

# Filing Supplies

## PRODUCT CATALOG

Folders | Indexes | Chart Dividers | Fasteners | Pockets | Labels | Forms  
Appointment Products | Storage | Misc Filing Products

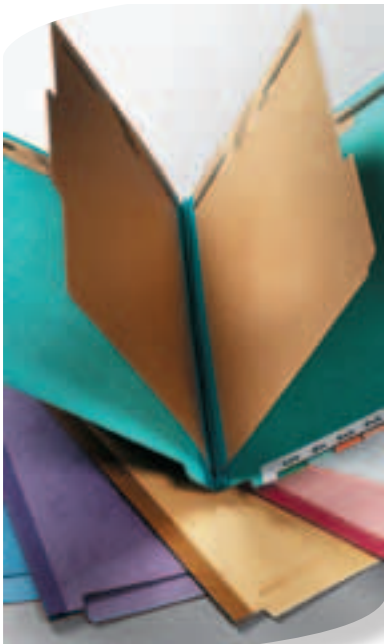

**SIMPLE SOLUTIONS  
TO IMPROVE RECORDS  
MANAGEMENT**

# Index

<b>A</b>		Pressboard	19	<b>P</b>	
Adhesive Dividers	34	Tyvek Expansion	13-14, 18-19	Pediatric Growth Charts	85
Adhesive Fasteners	23	Tyvek Laminated	20	PMA Compatible Labels	36, 55
Adhesive Pockets	25	File Name Labels	60	PMA Compatible Year Labels	55
Aging Labels	55-57	File Outguides	24	Pocket Folders	10-12, 14
Allergy Labels	64-66	File Pockets	15-16	Pockets Factory Applied	25
Alphabetic Labels	36-48	<b>FILE POCKETS</b>		Pockets File	10-12, 15-16
Ames Compatible Labels	37, 49, 55, 57	Adhesive Paper	25	Pockets See Through	26
Appointment Cards	90-93	Adhesive SeeThrough	26	P.O.S. Compatible Labels	44, 53, 55
<b>B</b>		EndTab	15-16	Pressure Sensitive Fasteners	23
Barkley Compatible Labels	38, 49, 55, 56	Mini	16	Pressure Sensitive Pockets	26
Bibbero Compatible Labels	39	TopTab	16	Progress Notes	31-33, 86, 88
Bonded Fasteners	2	File Shelving	96-99	<b>R</b>	
<b>C</b>		Fileback Dividers	28-29, 34	Recall Cards	90-93
Cabinets Open Shelf	96-97	Foamclip Fasteners	23	Reinforcing Strips	23, 61
Carts File	94-95	<b>FORMS</b>		Reynolds + Reynolds Comp. Labels	45, 53, 55
Centerpoint Filing	21-22	Clinical	84-86	<b>S</b>	
ChargeOut Slips	24	Dental	88-89	Safeguard Compatible Labels	47, 53, 55
Chart Divider Tabs	32-33	Insurance (HCFA)	87	SelfAdhesive Dividers	34
Chart Dividers	28-33	Medical	84-87	Shelving	96-99
Chart Fasteners	2, 23	Patient SignIn	87	Slash Pockets	15
Chart Labels	64-82	<b>G</b>		Smead Compatible Labels	46, 53-54, 55
Classification Folders	13-14	GBS/VRE Compatible Labels	41, 50, 55	Solid Color Labels	58-59, 83
Clinical Forms	84-89	Growth Charts	85	Spanish Labels	71
Code-A-Print Labeling Software	63	<b>H</b>		Stackable Shelving	96, 98
Collection Labels	71, 74-81	HCFA Claim Forms	87	StakN Lok Shelving	98-99
ColorCoded Labels	36-60	HIPAA Labels	67	Strip Labels	2, 63
Colored Folders	3, 9-10, 13, 15-18, 20	<b>I</b>		Sycom Compatible Labels	38, 49
Colored Pockets	15-16	Index Tabs	28-33	<b>T</b>	
COL'R TAB Compatible Label	39, 50, 55	Index Dividers-Stock	31	TAB Compatible Labels	48, 54, 55, 57
Colwell Jewel Tone Compatible Labels	40, 50, 55	Index Sets-Stock	30	Track Systems	97-99
Communication Labels	64-82	InHealth (PFSI) Compatible Labels	45	Traco Compatible Labels	47, 55
Confidential SignIn System	87	<b>J</b>		Transcription Labels	62
Controlled Alpha Placement System	37	Jeter Compatible Labels	42-43, 51-52, 55-57, 59	Twin Prong Fasteners	23
ControlOfax Compatible Labels	40, 50, 55	<b>K</b>		<b>UV</b>	
Conversion Tabs & Flaps	23-24	Kraft Pockets	16, 25	UClip Fasteners	23
Custom Chart Dividers	28-29	<b>L</b>		UFileM Strips	11, 12, 23
Custom Folders	2, 19	<b>LABELS</b>		Vinyl Outguides	24
Custom Installed Fasteners	2-3	Aging	55-57	Vinyl Pockets	26
<b>D</b>		Allergy	64-66	<b>XYZ</b>	
Datafile Compatible Labels	41, 50	Alphabetic	36-48	Year Labels	55, 57
Dental Charting System	88-89	Billing	71-80	Ziplock Pockets	26
Divider Sheets/Tabs	32-33	Blank	60, 62-63, 83		
Dividers Custom	28-29	Chart	64-82		
Dividers Fileback	28-29, 34	Collection	71, 74-81		
Dividers SelfAdhesive	28-29, 34	ColorCoded	36-60		
DocuClip Fastener	23	Communication	64-82		
<b>E</b>		Designator	58-59		
Earflap	23	HIPAA	67		
EndTab Folders	3-15, 17-22	Insurance	73-75, 81-82		
Envelopes File	16	Laser	60, 62, 83		
Envelopes HCFA	87	MAP Comparable	55		
Expanding Fileback	34	Month	56-57		
<b>F</b>		Name	60		
Fasteners Custom Installed	2-3	Numeric	49-54		
Fasteners Standard	2-3, 23	Protectors	61		
Fastfix™	61	Signature	87		
File Cabinets	94-99	Software	63		
File Carts	94-95	Solid Color	58-59, 83		
File Doctor Compatible Labels	41	Spanish	71		
File Envelopes	16	Transcription	62		
File Fasteners	2, 23	Year	55, 57		
File Folders	1-22	Label Protectors	61		
<b>FILE FOLDERS</b>		Laptop Storage	95		
Classification	13-14	Laser Appointment Cards	90-93		
Colored	3, 9-10, 13, 15-18, 20	LockIt Pockets	26		
Custom	2, 19	<b>M</b>			
Cutless™	6	Medical Alert Labels	68, 70		
EndTab	3-15, 17-22	Medical Charting System	84		
Expansion	5, 13-14, 18-19	Month Labels	56-57		
Hanging	21-22	Mylar Protectors	61		
Kardex Compatible	17-18	<b>N</b>			
Mylar Reinforced	5, 7, 14	Name Label Protectors	61		
Pocket	10-12, 15-16	Name Labels	60		
Printed	2	Numeric Labels	49-54		
Watershed™	6	<b>O</b>			
W-Fold	5	On-Demand Labels	63		
w/Dividers	13-14	Open Shelf Folders	3-15, 17-20		
w/Fasteners	3-13, 17-18	Outguides	24		
w/Pockets	10-12, 14				

Stock Folders 1

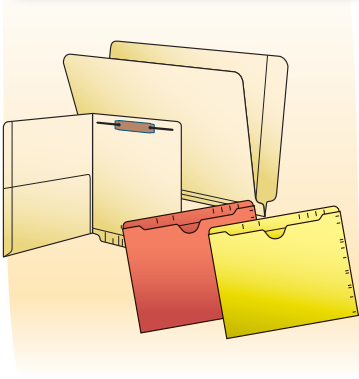

Kardex Comparable 17



Pressboard 19



Fasteners 23

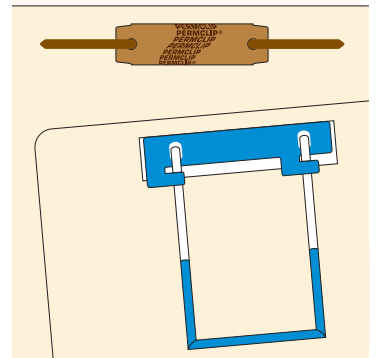

Outguides 24



Pockets 25

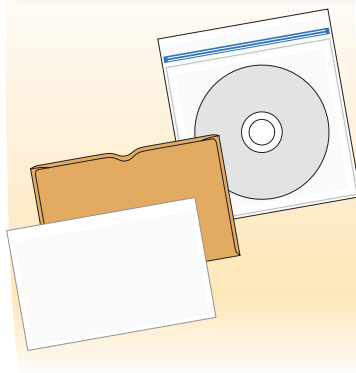

Stock Chart Dividers 30

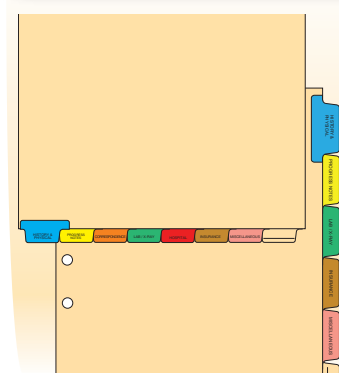

Index Tabs 32

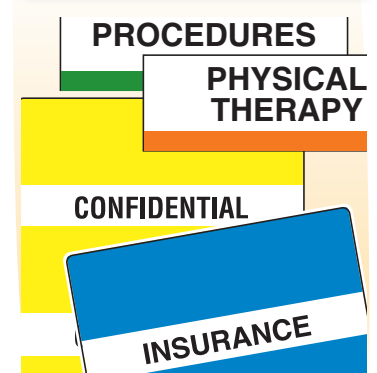

Self Adhesive Dividers 34

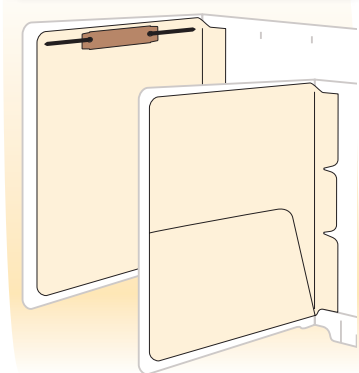

Color Code Labels 36



Month & Year Labels 55

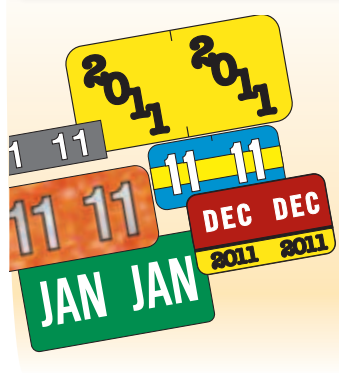

CodeAPrint 63



Chart Labels 64

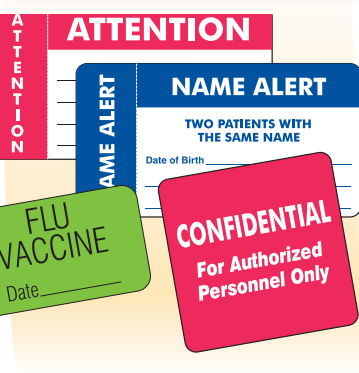

Forms 84

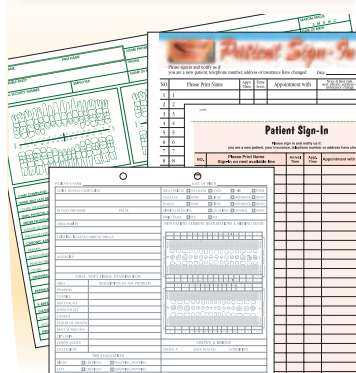

Appt Reminder Cards 90



Shelving 94



# FOLDERS

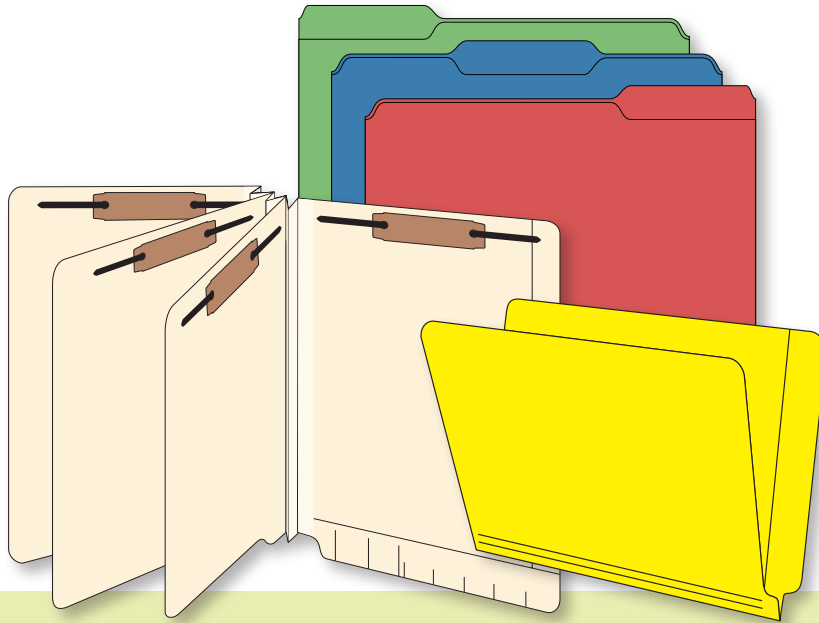

## File Folders

The folder is the most fundamental record management tool for

- document storage and retrieval
- information management
- document privacy and protection
- presentation

## From Stock to Custom and In-Between

We feature over 100 stock file folders and file pockets in a wide range of sizes and colors to match many of today's most popular systems. From end tab to top tab, manila or color, dividers, and expansion, we're bound to have a solution to your filing needs.

In addition to the great selection of stock file folders, we offer a large collection of value-added folder components such as fasteners, dividers, pockets, and labels.

When a stock or value-added solution doesn't meet your filing or presentation needs, we can customize a folder that satisfies your exact requirements.

## Markets

Our custom filing products and solutions can be tailored to enhance a variety of industry filing applications.

HEALTHCARE



LEGAL



AUTOMOTIVE



INSURANCE / BANKING



# WE'RE CUSTOM FILING EXPERTS

Whether it's a simple printed logo, or a custom crafted classification folder, our expertise and craftsmanship are unmatched.

## CUSTOM OPTIONS INCLUDE

- Custom Construction
- Paper Colors & Weights
- Fasteners
- Printing
- Dividers
- Indexes
- Applied Labels
- Constructed Pockets
- Applied Pockets
- Reinforcing
- Custom Expansion
- Bar Coding
- Consecutive Numbering

TYVEK GUSSET EXPANSION

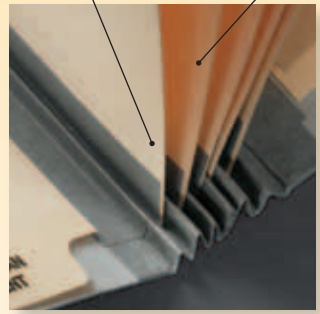

DIVIDERS



CUSTOM CONSTRUCTION



CONSTRUCTED POCKET



BORDER PRINTING



CONSECUTIVE NUMBERING



PRINTING

APPLIED STRIP LABEL WITH BAR CODE

# Fasteners

Factory installed fasteners or clips can be ordered in any position. Please refer to the charts for clip and fastener position numbers.

**Heat Bonded** - Heat bonded to the surface of the folder and nearly impossible to rip from the folder. Available in 1" or 2" capacity.

**Embedded** - Applied through the back of the folder and has a lower profile. Available in 1" or 2" capacity.

**Medi-Clip** - This unique fastener converts any file folder into a ring binder, loose-leaf format.

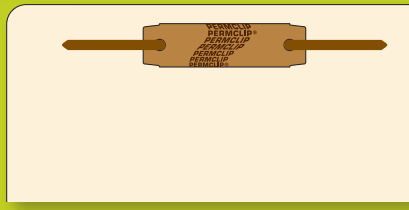

BONDED

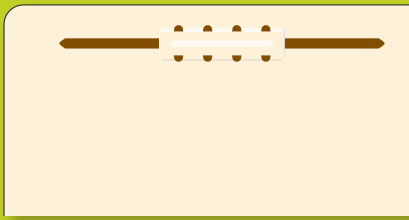

EMBEDDED

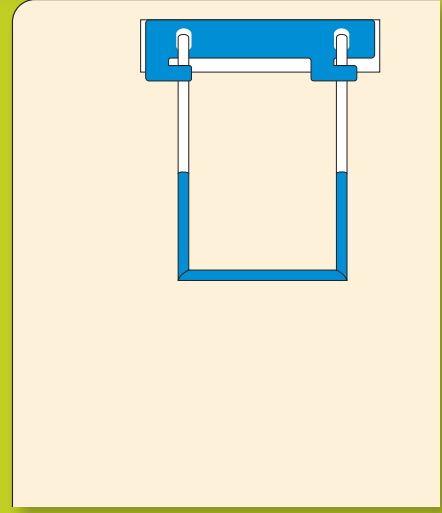

MEDI-CLIP

3	1
7	6 5 8
4	2

RIGHT HAND TAB

When ordering, state the folder item number, size of the fastener, type of the fastener and the desired position(s).

**Example:** MRS10, 2" fastener, position #1 and #3.

Pay special attention to fastener positions when ordering a left-hand tab folder or pocket folders.

3	1
7	6 5 8
4	2

LEFT HAND TAB

# Reinforced End Tab Folders

## MRS10 & MRS20 | CRS10 & CRS15

Comparable to Tab, Smead, Barkley

- Overall Size: 9-1/2" H x 12-1/4" W
- Tab Length: 8-1/2"
- Front Size: 9-1/2" H x 11-3/4" W
- Scored for 3/4" Expansion
- Undercut to: 11-3/8"
- 10 Scored Tick Marks

Item #	Paper Weight	Fastener Position	Qty per box	Qty per Ctn	Lb / 1,000
MRS10	11pt	None	100	500	90
MRS1021	11pt	1	50	250	95
MRS10213	11pt	1 & 3	50	250	100
MRS20	14pt	None	50	250	110
MRS2021	14pt	1	50	250	115
MRS20213	14pt	1 & 3	50	250	120

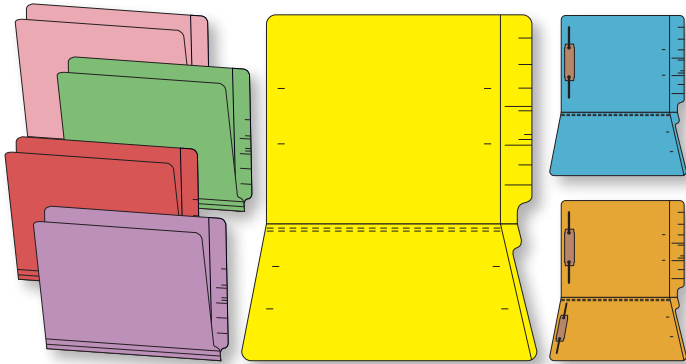
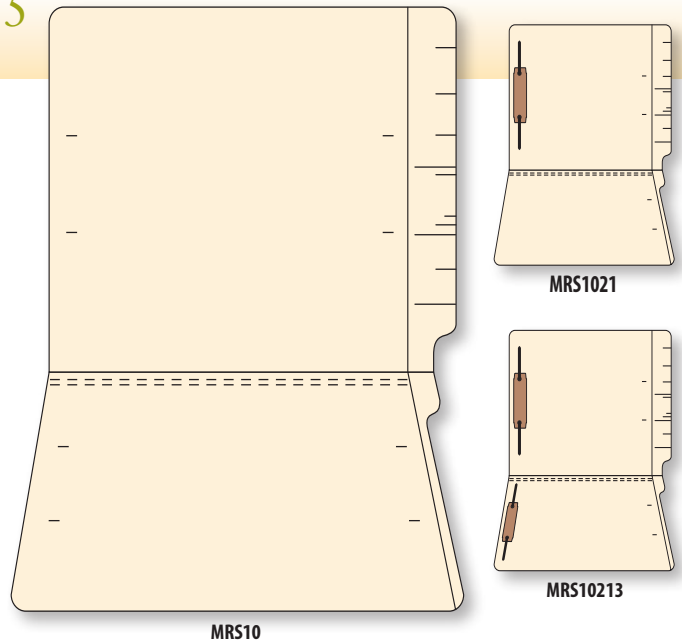

Item #	Paper Weight	Fastener Position	Qty per box	Qty per Ctn	Lb / 1,000
CRS10 + color	11pt	None	100	500	95
CRS1021 + color	11pt	1	50	250	100
CRS10213 + color	11pt	1 & 3	50	250	105
CRS15 + color	15pt	None	50	250	110
CRS1521 + color	15pt	1	50	250	115
CRS15213 + color	15pt	1 & 3	50	250	120

18 Available 11pt Colors								
red	yellow	pink	green	white	brown	blue	orange	tan
gray	dark orange	dark gray	dark blue	dark green	purple	canary	gldnrd	lavnder

11 Available 15pt Colors					
red	canary	pink	green	white	lavnder
gray	dark orange	dark gray	dark blue	gldnrd	

### RIGHT HAND TAB FOLDER

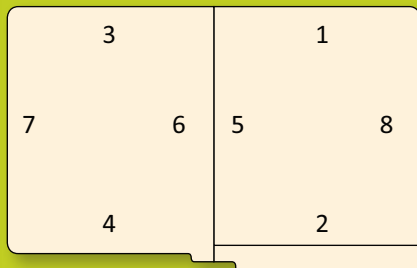

## Fastener Postions

Fasteners or clips can be ordered in any position. Please refer to the charts for clip and fastener position numbers. When ordering, state the folder item number, size of the fastener, type of the fastener and the desired position(s).

**Example:** MRS10, 2" fastener, position #1 and #3.

Pay special attention to fastener postions when ordering a left-hand tab folder or pocket folders.

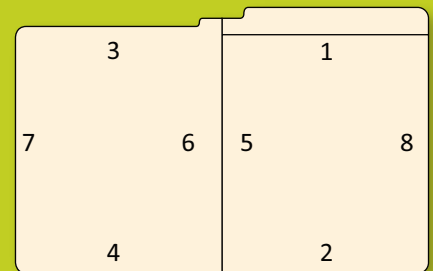

LEFT HAND TAB FOLDER

# Reinforced End Tab Folders

## JRET11 & JRET14

Comparable to Jeter

Overall Size: 9-1/2" H x 12-1/4" W, Front Size: 9-1/2" H x 11-3/4" W,  
Undercut to: 11-3/8", Tab Length: 8-1/2", Scored for 3/4" expansion

Item #	Paper Weight	Fastener Position	Qty per box	Qty per Ctn	Lb / 1,000
JRET11	11pt	None	100	500	90
JRET1121	11pt	1	50	250	95
JRET11213	11pt	1 & 3	50	250	100
JRET14	14pt	None	50	250	110
JRET1421	14pt	1	50	250	115
JRET14213	14pt	1 & 3	50	250	120

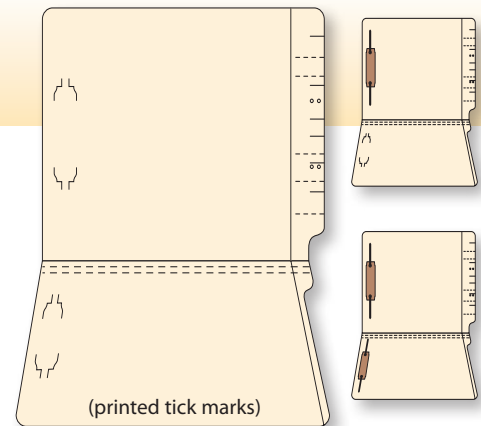

## BET11 & BET14

Comparable to Barkley

Overall Size: 9-1/2" H x 12-1/4" W, Front Size: 9-1/2" H x 11-3/4" W,  
Undercut to: 11-3/8" Tab Length: 8-1/2", Scored for 3/4" expansion

Item #	Paper Weight	Fastener Position	Qty per box	Qty per Ctn	Lb / 1,000
BET11	11pt	None	100	500	90
BET1121	11pt	1	50	250	95
BET11213	11pt	1 & 3	50	250	100
BET14	14pt	None	50	250	110
BET1421	14pt	1	50	250	115
BET14213	14pt	1 & 3	50	250	120

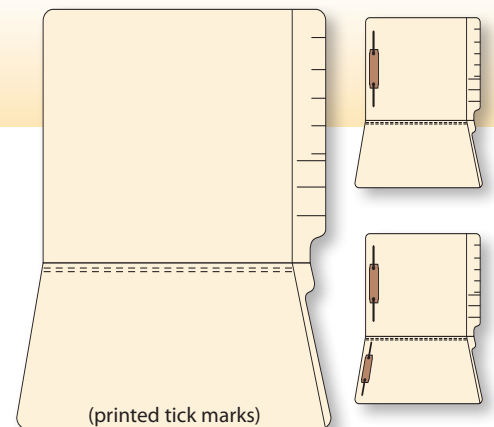

## MR11 & MR15

Comparable to Jeter

Overall Size: 9-1/2" H x 12-1/4" W, Front Size: 9-1/2" H x 11-3/8" W,  
Tab Length: 9-3/8", Scored for 3/4" expansion

Item #	Paper Weight	Fastener Position	Qty per box	Qty per Ctn	Lb / 1,000
MR11	11pt	None	100	500	95
MR1121	11pt	1	50	250	100
MR11213	11pt	1 & 3	50	250	105
MR15	14pt	None	50	250	110
MR1521	14pt	1	50	250	115
MR15213	14pt	1 & 3	50	250	120

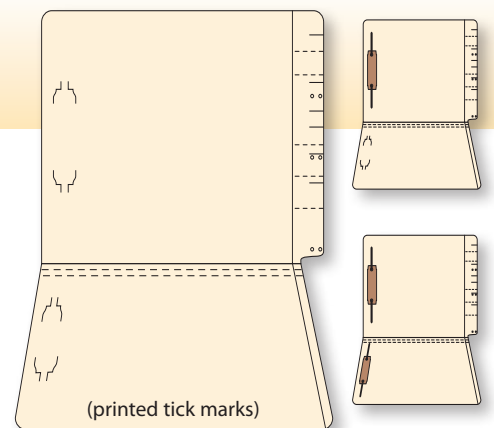

## MAM11 & MAM15

Comparable to Ames

Overall Size: 9-1/2" H x 12-1/4" W, Front Size: 9-1/2" H x 11-3/8" W,  
Tab Length: 9", Scored for 1-3/8" expansion, Interlocking reinforced top and end tab

Item #	Paper Weight	Fastener Position	Qty per box	Qty per Ctn	Lb / 1,000
MAM11	11pt	None	100	500	105
MAM1121	11pt	1	50	250	110
MAM11213	11pt	1 & 3	50	250	115
MAM15	14pt	None	50	250	130
MAM1521	14pt	1	50	250	135
MAM15213	14pt	1 & 3	50	250	140

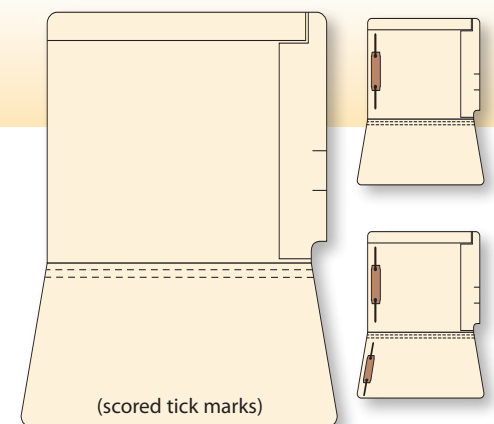

# Reinforced End Tab Folders

## M11SH

Comparable to Barkley

- Overall Size: 9-1/2" H x 12" W
- Front Size: 9-1/2" H x 11-1/4" W
- Tab Length: 8-1/2"
- Scored for 3/4" expansion
- Reinforced top and end tab

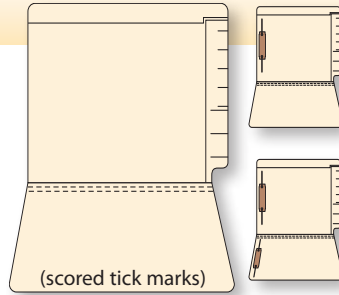

Item #	Paper Weight	Fastener Position	Qty per box	Qty per Ctn	Lb / 1,000
M11SH	11pt	None	100	500	105
M11SH21	11pt	1	50	250	110
M11SH213	11pt	1 & 3	50	250	115

## MRST15

Comparable to Barkley

- Overall Size: 9-1/2" H x 12-1/4" W
- Front Size: 9-1/2" H x 11-3/4" W
- Undercut to: 11 3/8"
- Tab Length: 9-3/8"
- Scored for 1-3/8" expansion
- Reinforced top and end tab

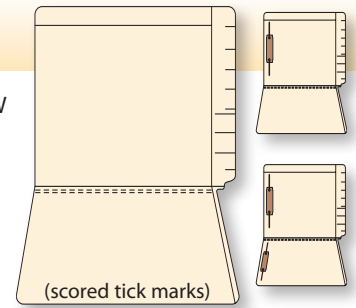

Item #	Paper Weight	Fastener Position	Qty per box	Qty per Ctn	Lb / 1,000
MRST15	14pt	None	50	250	130
MRST1521	14pt	1	50	250	135
MRST15213	14pt	1 & 3	50	250	140

## MW15

2" W-Fold Expansion Folder  
Comparable to Ames

- Overall Size: 9-1/2" H x 12-1/4" W
- Front Size: 9-1/2" H x 11-3/8" W
- Tab Length: 9-3/8"
- Scored for 2" W-fold expansion
- Interlocking reinforced top and end tab
- Ships flat

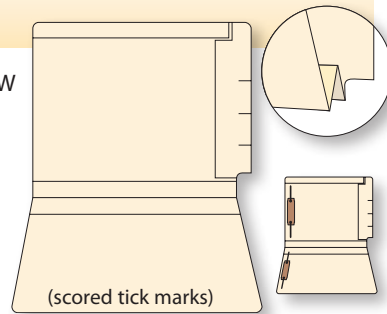

Item #	Paper Weight	Fastener Position	Qty per box	Qty per Ctn	Lb / 1,000
MW15	14pt	None	200	95	
MW1521	14pt	1	150	100	
MW15213	14pt	1 & 3	150	105	

## MSF11

Comparable to Col'R'Tab, GBS/VRE

- Overall Size: 9-1/2" H x 12" W
- Front Size: 9-1/8" H x 11-1/2" W
- Top Undercut to: 8-3/4"
- Side Undercut to: 11-1/4"
- Tab Length (top & end): 8-5/8"
- Scored for 3/4" expansion
- Reinforced top and end tab

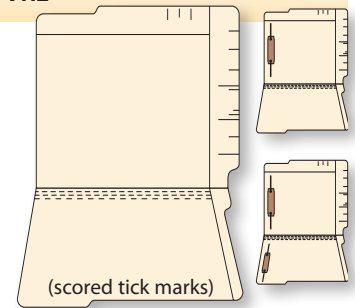

Item #	Paper Weight	Fastener Position	Qty per box	Qty per Ctn	Lb / 1,000
MSF11	11pt	None	100	500	100
MSF1121	11pt	1	50	250	105
MSF11213	11pt	1 & 3	50	250	110

## M11BC

Border Printed Folder

- Overall Size: 9-1/2" H x 12-1/4" W
- Front: 9-1/2" H x 11-3/4" W
- Undercut to: 11-3/8"
- Tab Length: 8-1/2"
- Scored for 3/4" expansion



M11BC Colors				
red	yellow	pink	green	brown
gray	orange	tan	blue	violet

Item #	Paper Weight	Fastener Position	Qty per box	Qty per Ctn	Lb / 1,000
M11BC + color	11pt	None	100	500	90
M11BC21 + color	11pt	1	50	250	95
M11BC213 + color	11pt	1 & 3	50	250	100

## MRS20ETMY

Mylar Reinforced End Tab

14pt letter size manila double ply end tab folder.

Mylar reinforced front, back, and end tab is perfect for heavy use.

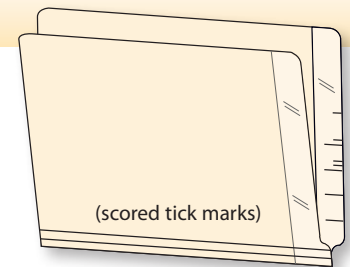

Item #	Fastener Position	Qty per box	Qty per Ctn	Lb / 1,000
MRS20ETMY	None	50	250	110
MRS20ETMY21	1	50	250	115
MRS20ETMY213	1 & 3	50	250	120



# Reinforced End Tab Folders

## WaterShed & CutLess Folders

Comparable to Smead

- Overall Size: 9-1/2" H x 12-1/4" W
- Front Size: 9-1/2" H x 11-3/4" W
- Undercut to: 11-3/8"
- Tab Length: 8-1/2"
- Scored for 3/4" expansion
- Reinforced end tab

### CUTLESS™

Paper Cut Resistant File Folders

Cutless® File Folders are specially formulated to reduce paper cuts by up to 70% without sacrificing durability.

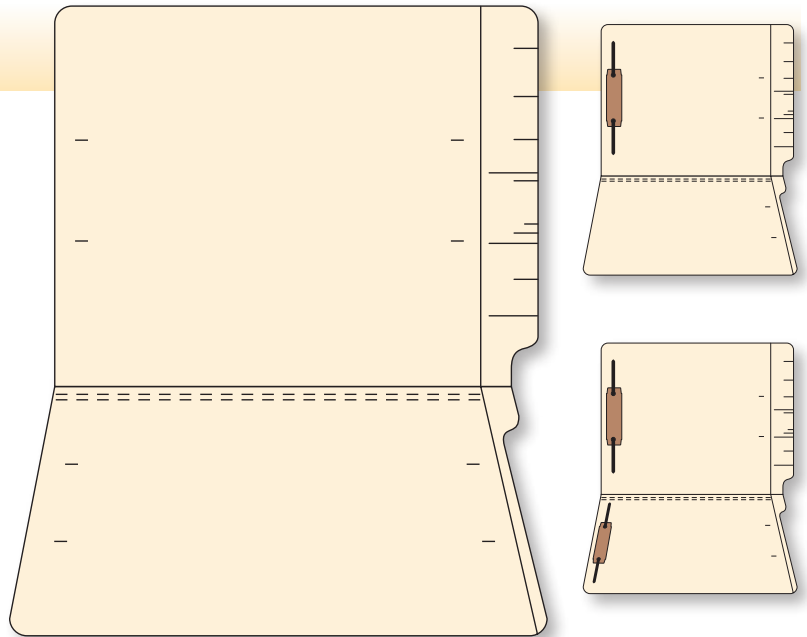

### WaterShed™

Water Resistant File Folders

WaterShed® File Folders are specially formulated to resist spills and rain, protecting your files from water damage. Liquids simply bead up and can be wiped clean with a cloth. WaterShed® Folder's special surface can be printed or written on with a pen or a pencil.



Item #	Papver Weight	Fastener Position	Qty per box	Qty per Ctn	Lb / 1,000
CSET15 (Cutless)	15pt	None	50	250	110
CSET1521	15pt	1	50	250	115
CSET15213	15pt	1 & 3	50	250	120
WSSET11 (Watershed)	11pt	None	100	500	90
WSSET1121	11pt	1	50	250	95
WSSET11213	11pt	1 & 3	50	250	100

## Added-Value

A variety of components, such as printing, fasteners, pockets, dividers, indexes, and labels, can be added to any folder to best meet your document filing and retrieval needs.



printing page 2

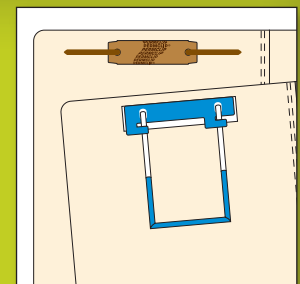

fasteners page 2, 23



pockets page 25-26

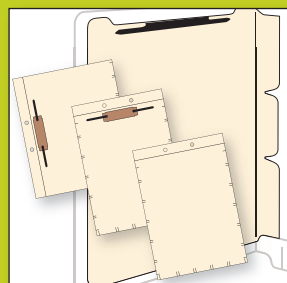

dividers page 34

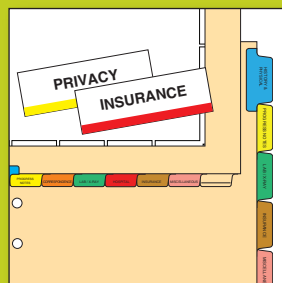

indexes page 28-33



labels page 35-82

# Single Ply End Tab Folders

## MS100 & MS200

Comparable to Tab, Smead, Barkley

- Overall Size: 9-1/2" H x 12-1/4" W
- Front Size: 9-1/2" H x 11-3/4" W
- Undercut to: 11-3/8"
- Tab Length: 8-1/2"
- Scored for 3/4" expansion
- 11 or 14pt

Item #	Paper Weight	Fastener Position	Qty per box	Qty per Ctn	Lb / 1,000
MS100	11pt	None	100	500	75
MS10021	11pt	1	50	250	80
MS100213	11pt	1 & 3	50	250	85
MS200	14pt	None	50	250	95
MS20021	14pt	1	50	250	100
MS200213	14pt	1 & 3	50	250	105

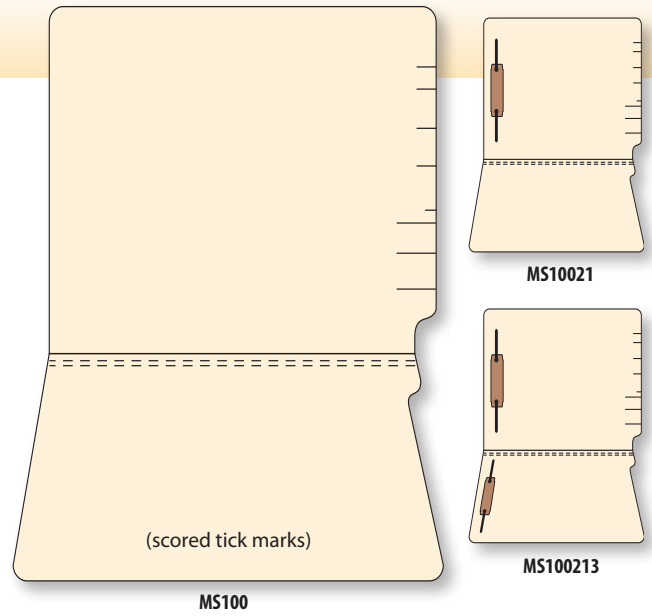

## JET14

Comparable to Jeter

- Overall Size: 9-1/2" H x 12-1/4" W
- Front Size: 9-1/2" H x 11-3/4" W
- Undercut to: 11-3/8"
- Tab Length: 8-3/8"
- Scored for 3/4" expansion

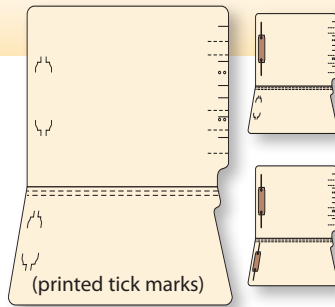

Item #	Paper Weight	Fastener Position	Qty per box	Qty per Ctn	Lb / 1,000
JET14	14pt	None	100	500	95
JET1421	14pt	1	50	250	100
JET14213	14pt	1 & 3	50	250	105

## PETR14

Comparable to PMA

- Overall Size: 9-1/2" H x 12-1/4" W
- Front Size: 9-1/2" H x 11-3/4" W
- Tab Length: 9"
- Scored for 3/4" expansion

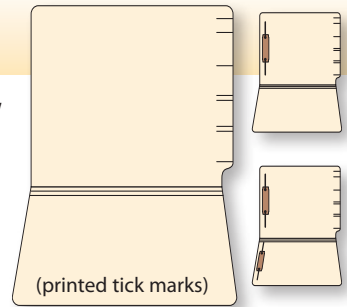

Item #	Paper Weight	Fastener Position	Qty per box	Qty per Ctn	Lb / 1,000
PETR14	14pt	None	100	500	95
PETR1421	14pt	1	50	250	100
PETR14213	14pt	1 & 3	50	250	105

## SS18 & SS18MMY

18pt Single Ply

- Overall Size: 9-1/2" H x 12-1/4" W
- Front Size: 9-1/2" H x 11-3/4" W
- Undercut to: 11-3/8"
- Tab Length: 8-1/2"
- Scored for 3/4" expansion
- Optional Mylar reinforced spine
- Packed 50/box

Item #	Paper Weight	Fastener Position	Lb / 1,000
SS18M	18pt	None	150
SS18M21	18pt	1	155
SS18M213	18pt	1 & 3	160
SS18MMY	18pt	None	150
SS18MMY21	18pt	1	155
SS18MMY213	18pt	1 & 3	160

items MY include Mylar reinforced spine

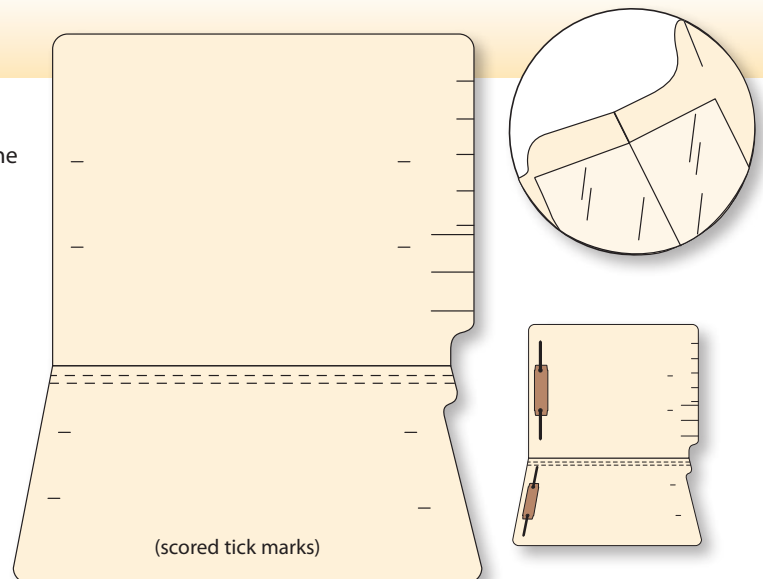

# Single Ply End Tab Folders

## VR11 & VR15

Comparable to GBS / VRE

- Overall Size: 9-1/2" H x 12-1/4" W
- Front Size: 9-1/2" H x 11-3/8" W
- Printed tick marks on back of folder
- Tab Length: 8-7/8"
- Scored for 3/4" expansion
- 11 or 14pt

Item #	Paper Weight	Fastener Position	Qty per box	Qty per Ctn	Lb / 1,000
VR11	11pt	None	100	500	75
VR1121	11pt	1	50	250	80
VR11213	11pt	1 & 3	50	250	85
VR15	14pt	None	50	250	95
VR1521	14pt	1	50	250	100
VR15213	14pt	1 & 3	50	250	105

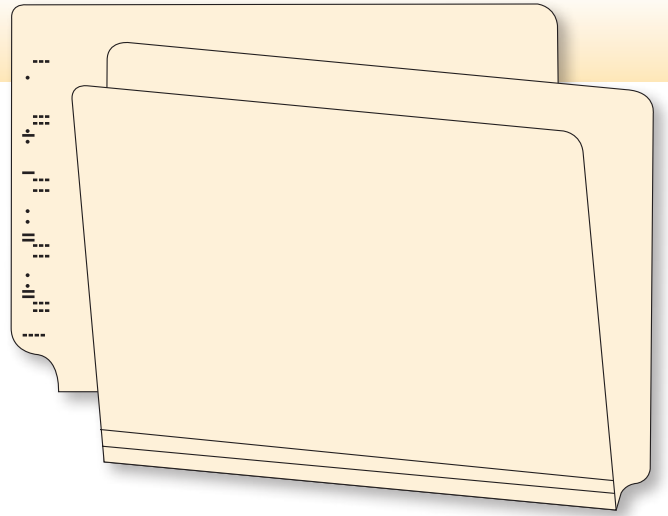

## MS15

Comparable to Jeter

- Overall Size: 9-1/2" H x 12-1/4" W
- Front Size: 9-1/2" H x 11-3/8" W
- Tab Length: 9-3/8"
- Scored for 3/4" expansion

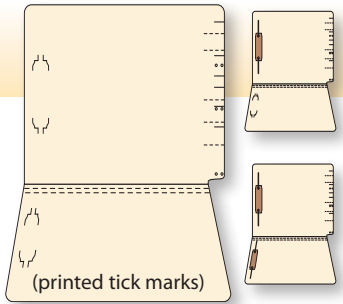

Item #	Paper Weight	Fastener Position	Qty per box	Qty per Ctn	Lb / 1,000
MS15	14pt	None	100	500	95
MS1521	14pt	1	50	250	100
MS15213	14pt	1 & 3	50	250	105

## PETL14

14pt Single Ply End Tab

- Overall Size: 9-1/2" H x 12-1/4" W
- Front Size: 9-1/2" H x 11-3/4" W
- Tab Length: 9"
- Scored for 3/4" expansion

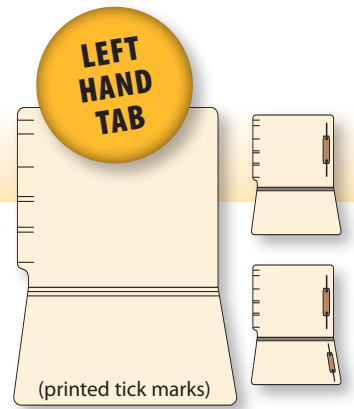

Item #	Paper Weight	Fastener Position	Qty per box	Qty per Ctn	Lb / 1,000
PETL	14pt	None	100	500	95
PETL22	14pt	2	50	250	100
PETL224	14pt	2 & 4	50	250	105

### RIGHT HAND TAB FOLDER

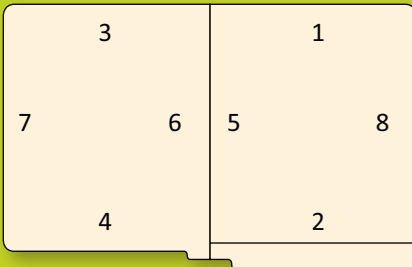

## Fastener Postions

Fasteners or clips can be ordered in any position. Please refer to the charts for clip and fastener position numbers. When ordering, state the folder item number, size of the fastener, type of the fastener and the desired position(s).

**Example:** *MRS10, 2" fastener, position #1 and #3.*

Pay special attention to fastener postions when ordering a left-hand tab folder or pocket folders.

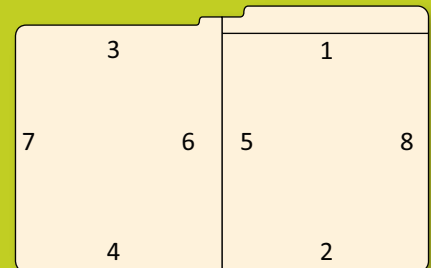

### LEFT HAND TAB FOLDER

# Top Tab Folders

## MR50

Comparable to Smead, Barkley

Also Available in Colors page 17

- Overall Size: 9-1/2" H x 11-3/4" W
- Front Size: 8-7/8" H x 11-3/4" W
- Tab Length: 11-3/4"
- Scored for 3/4" expansion
- Straight Cut reinforced top tab

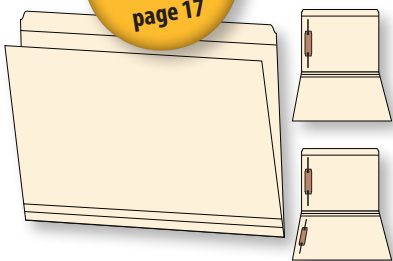

Item #	Paper Weight	Fastener Position	Qty per box	Qty per Ctn	Lb / 1,000
MR50	11pt	None	100	500	90
MR5021	11pt	1	50	250	95
MR50213	11pt	1 & 3	50	250	100

## M11TT

- Overall Size: 9-15/16" H x 11-3/4" W
- Front Size: 8-7/8" H x 11-3/4" H
- Tab Length: 8"
- Scored for 3/4" expansion
- Reinforced top tab

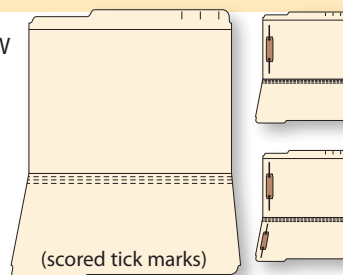

Item #	Paper Weight	Fastener Position	Qty per box	Qty per Ctn	Lb / 1,000
M11TT	11pt	None	100	500	90
M11TT21	11pt	1	50	250	95
M11TT213	11pt	1 & 3	50	250	100

## SM11

Comparable to Smead

- Overall Size: 9-1/2" H x 11-3/4" W
- Front Size: 9" H x 11-3/4"
- Full top tab
- Scored for 3/4" expansion
- Full reinforced right end
- 0-9 scale printed in two locations, top & right side on outside back panel

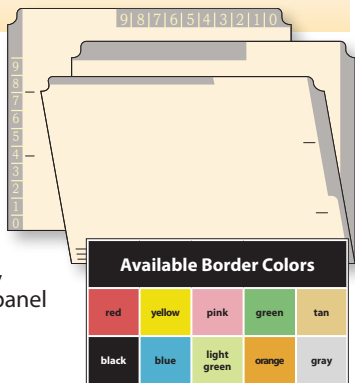

Available Border Colors

red	yellow	pink	green	tan
black	blue	light green	orange	gray

Item #	Paper Weight	Fastener Position	Qty per box	Lb / 1,000
SM11 + color	11pt	None	100	90
SM1121 + color	11pt	1	50	95
SM11213 + color	11pt	1 & 3	50	100

## M9518

Comparable to Smead, Barkley

- Overall Size: 9-1/2" X 11-3/4"
- Front Size: 8-7/8" X 11-3/4"
- Tab Length: 3-3/4"
- Scored for 3/4" expansion
- Packed 1 tab position per box
- Reinforced 1/3 cut top tab. Choose left, center or right position

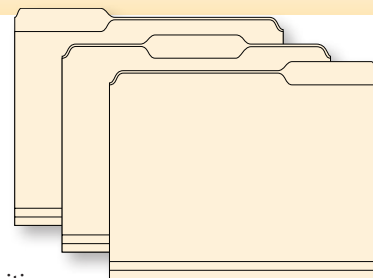

Item #	Paper Weight	Fastener Position	Qty per box	Lb / 1,000
M9518 + tab position	11pt	None	100	90
M951821 + tab position	11pt	1	50	95
M9518213 + tab position	11pt	1 & 3	50	100

## TTC11

Comparable to Smead, Barkley

Similar in construction to the M9518, this 11pt 1/3rd cut top-tab is available in manila and 10 pulp-dyed colors. Assorted tab positions packed per box.

- Overall Size: 9-1/2" X 11-3/4"
- Front Size: 8-7/8" X 11-3/4"
- Tab Length: 3-3/4"
- Scored for 3/4" expansion
- Reinforced 1/3 cut top tab.
- Assorted tabs packed per box
- Specify color when ordering



TTC11 Colors

manila	red
pink	canary
dark blue	dark orange
gldnrd	white
gray	lavnder
green	

Item #	Paper Weight	Fastener Position	Qty per box	Qty per Ctn	Lb / 1,000
TTC11	11pt	None	100	500	95
TTC1121	11pt	1	50	250	100
TTC11213	11pt	1 & 3	50	250	105

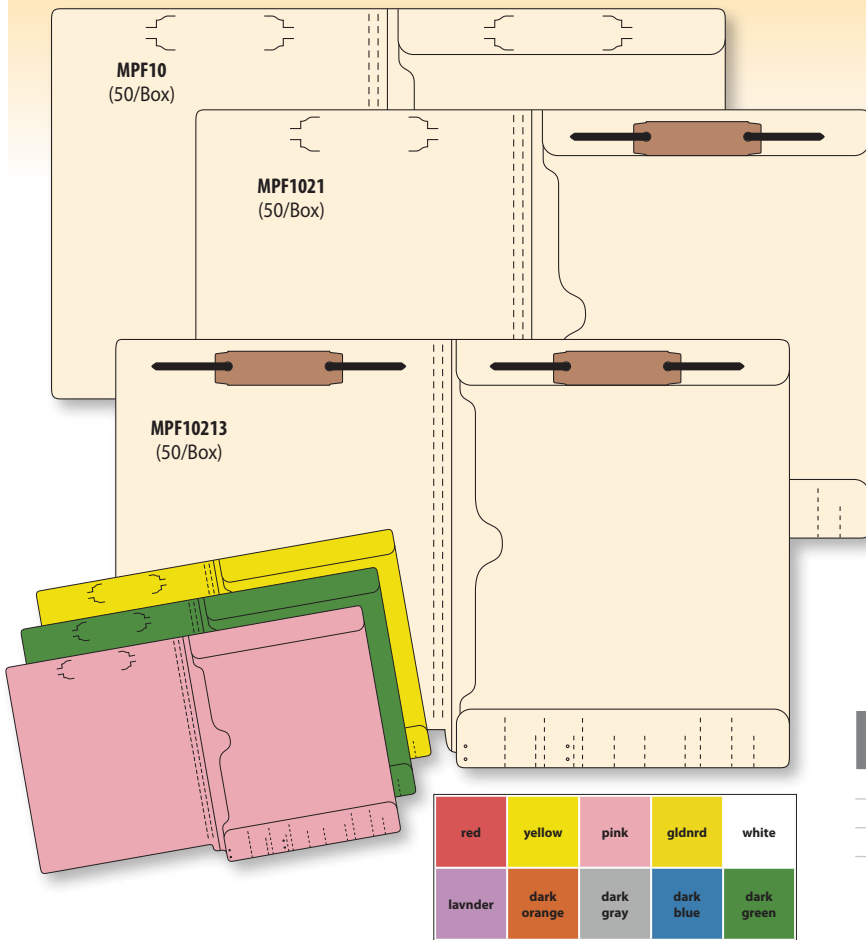

Structurally designed pocket folders and folders with installed pockets have become essential because of the broad assortment of documents and document sizes being stored today. Choose from a large selection of multi-functional pocket folders to meet your particular needs.

## MPF10

### Comparable to Barkley

Constructed from 11pt manila or colored stock with an integral side seam pocket sealed on three sides. Full size pocket is 9-3/8" H x 12-1/4" W and has printed label placement marks. Overall size is 9-1/2" H x 12-1/4" W.

Item #	Paper Weight	Fastener Position	Qty per box	Qty per Ctn	Lb / 1,000
MPF10	11pt	None	50	250	130
MPF1021	11pt	1	50	250	135
MPF10213	11pt	1 & 3	50	250	140

Specify color when ordering.

## MRSP10 & MRSP14

### Left Hand Single-Pocket Folder

- 11 & 14pt Manila and Colors
- 9-1/2" H x 12-1/4" W; pocket 5-3/4" D
- 8 scored tick marks

Item #	Paper Weight	Fastener Position	Qty per box	Qty per Ctn	Lb / 1,000
MRSP10	11pt	None	50	250	110
MRSP1021	11pt	1	50	250	115
MRSP14	14pt	None	50	250	150
MRSP1421	14pt	1	50	250	155

Specify color when ordering.

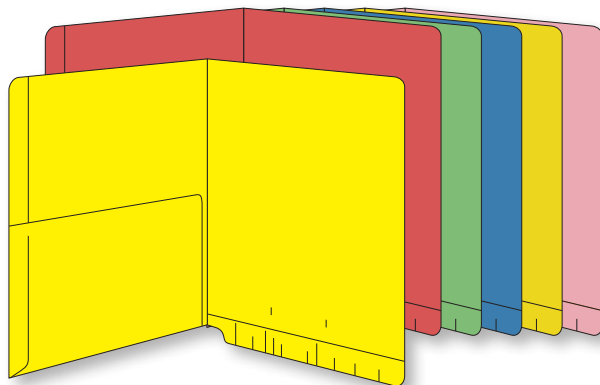
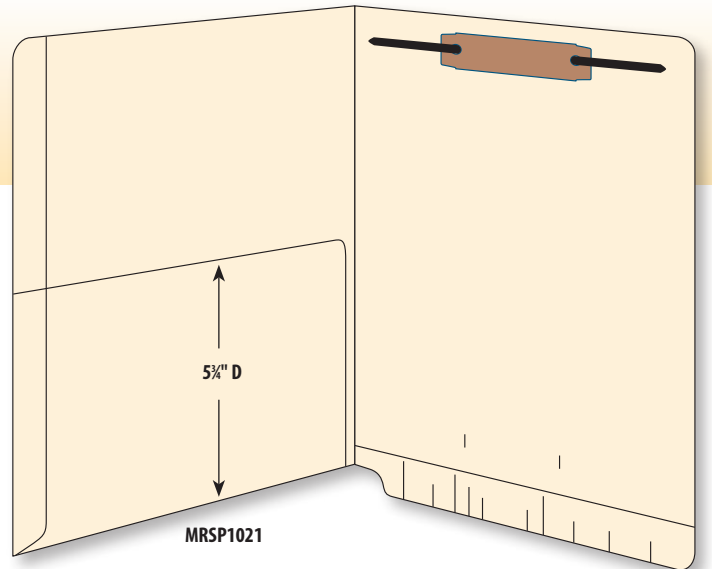

Available 11pt & 14pt Colors		
red	canary	pink
gldnrd	green	dark blue

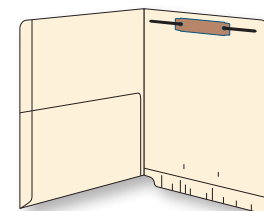

**MRSPDF10**  
available 9" H front manila only (50/Box)

# Pocket Folders

## MPFA10

Full Cut-Corner Pocket Folder

9-1/2" H x 12-1/4" W; pocket 9-3/8" H x 11-5/8" W

11pt manila stock, double ply tab with printed label placement marks.

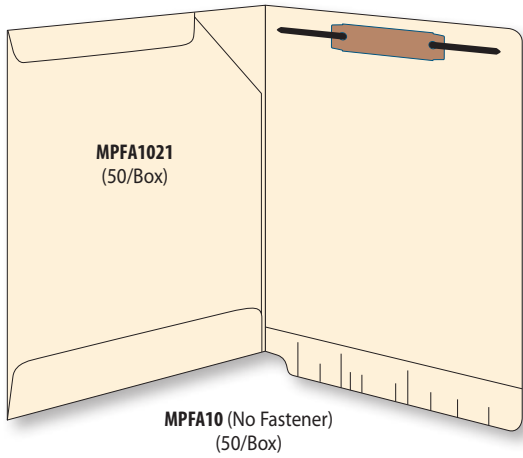

## MRSPR11

Right Hand Single-Pocket Folder

9-1/2" H x 12-1/4" W; pocket 5-3/4" H x 9" W

11pt manila stock, double ply tab with scored label placement marks.

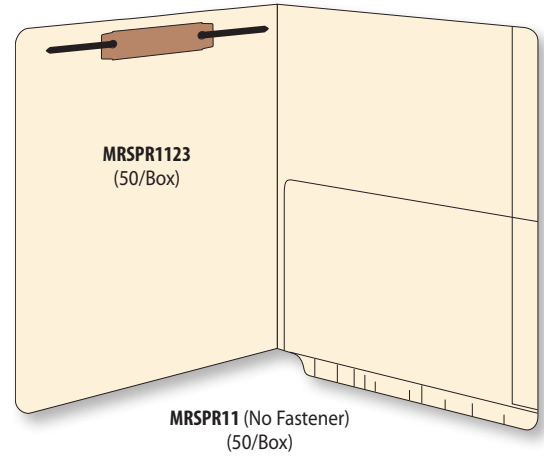

## Pre-assembled Pocket Folders

9-1/2" H x 12-1/4" W

Base folder is an 11pt manila MRS10 with scored label placement marks.

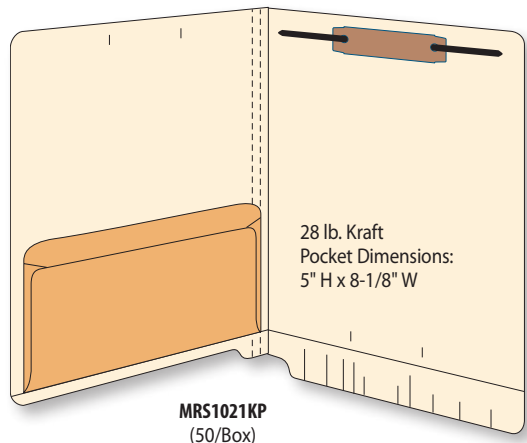
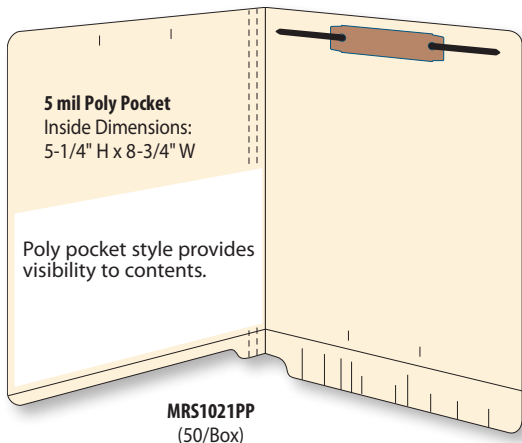
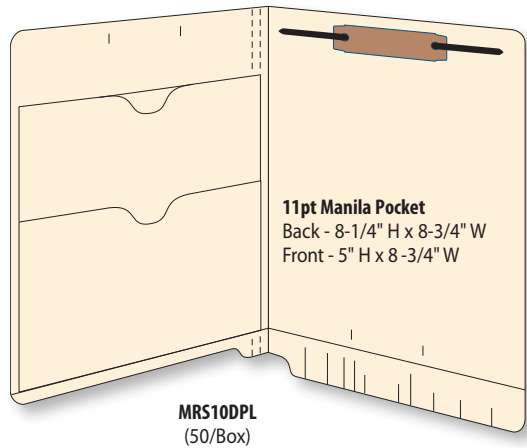
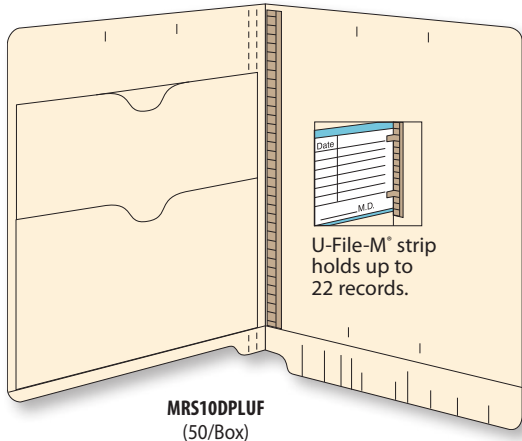

## MDPOUT

Double Outside-Pocket Folders  
9-1/2" H x 12-1/4" W

11 pt manila construction; Folder design is perfect for dental practices to hold panorex x-rays, photos, etc.

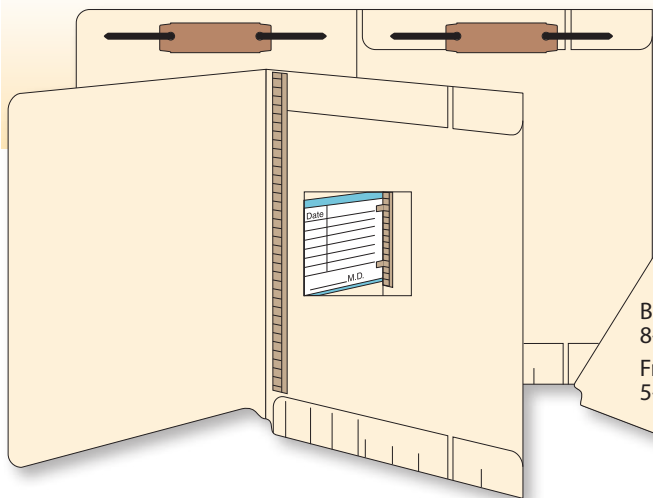

Back Pocket  
8-3/4" H x 12-1/4" W  
Front Pocket  
5-1/2" H x 12-1/4" W

**MDPOUT** - (50/Box)  
Double pocket folder with no additional fasteners installed

**MDPOUTF** - (50/Box)  
Includes a U-File-M® strip in position #5; holds up to 22 records

**MDPOUT213** - (50/Box)  
2" Bonded fasteners in positions 1 & 3 for maximum storage capacity

## MTTPK

Right Hand Single-Pocket Folder

9-1/2" H x 12-1/4" W; pocket 5-3/4" H x 9" W

11 pt manila stock, double ply tab with scored label placement marks.

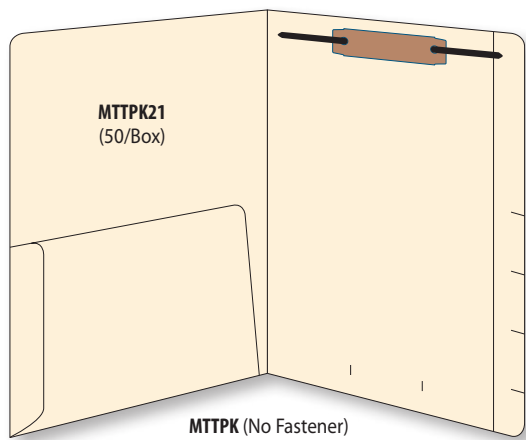

**MTTPK21**  
(50/Box)

**MTTPK** (No Fastener)  
(50/Box)

## Pocket Folders with Strength & Capacity

### MPFO14213

Full Size Pocket Folder — 9-1/2" H x 12-1/4" W

Constructed from a 14pt (MS15) folder with an 11 pt (FP12) pocket laminated to the inside provides maximum durability. Dimensions of pocket are 9-3/8" H x 12-1/4" W

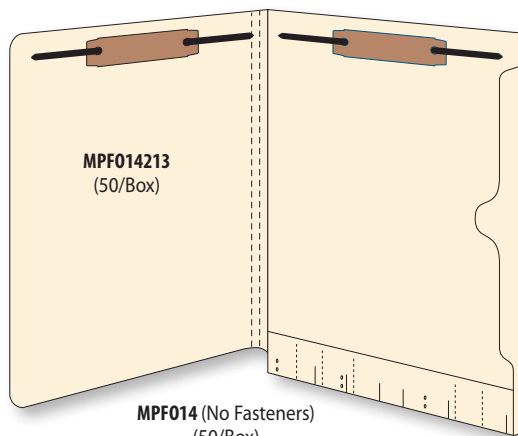

**MPFO14213**  
(50/Box)

**MPFO14** (No Fasteners)  
(50/Box)

### MPFDP10

Twin Pocket Folder — 9-1/2" H x 12-1/4" W

Constructed from 11 pt manila stock, folder has two pockets for storage of panorex x-rays, photos, etc.

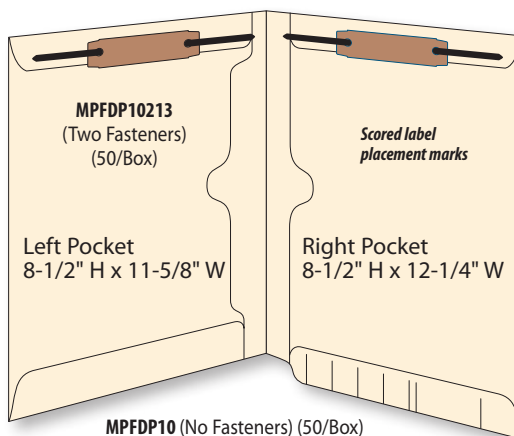

**MPFDP10213**  
(Two Fasteners)  
(50/Box)

*Scored label placement marks*

Left Pocket  
8-1/2" H x 11-5/8" W

Right Pocket  
8-1/2" H x 12-1/4" W

**MPFDP10** (No Fasteners) (50/Box)

stand alone  
pocket  
accessories  
page 25-26



# Divider / Classification Folders

## Folders with Manila Dividers

9-1/2" H x 12-1/4" W

Assembled from stock components, these folders feature an 11pt or 14pt reinforced folder with one or two 11pt manila dividers and 2" bonded fasteners. (25/box 125/ctn)

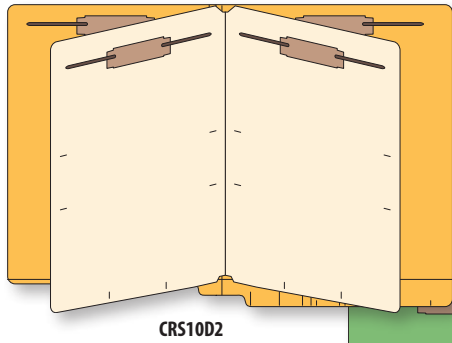

CRS10D2

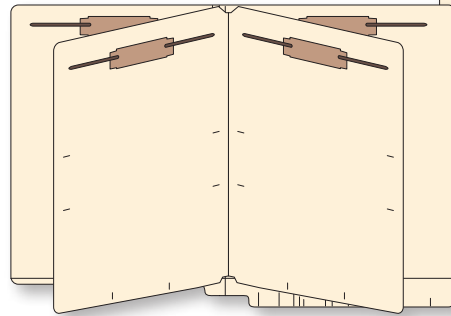

MRS20D2

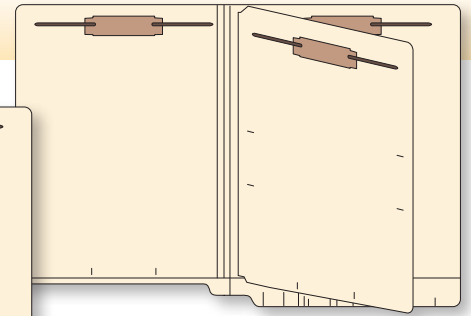

MRS10D1

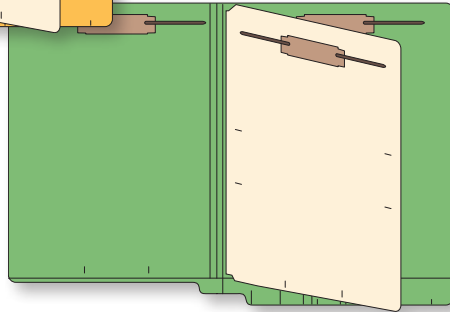

CRS10D1

**Divider folders allow the contents of each chart to be easily categorized and sub-divided.**



Item #	Paper Weight	Fasteners	Qty per box	Lb / 1,000
MRS10D1	11pt	4 total	25	150
MRS10D2	11pt	6 total	25	200
MRS20D1	14pt	4 total	25	195
MRS20D2	14pt	6 total	25	245
CRS10D1 + color	11pt	4 total	25	150
CRS10D2 + color	11pt	6 total	25	200
MRSD10D1*	11pt	4 total	25	150
MRSD10D2*	11pt	6 total	25	200

\* 9" high front panel

Specify color when ordering

## 18PT & 20PT Folders with Kraft Dividers

9-1/2" H x 12-1/4" W

Assembled from stock components, these folders feature a heavy weight folder with one or two 11pt brown kraft dividers.

All styles feature a 2" Tyvek expansion.

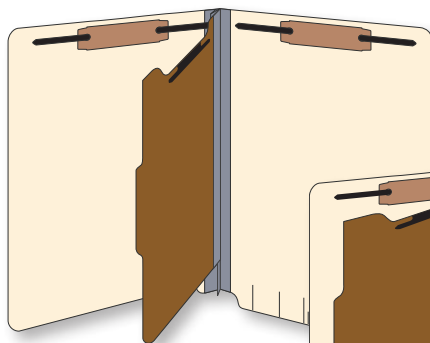

18PT1DM  
18pt Manila

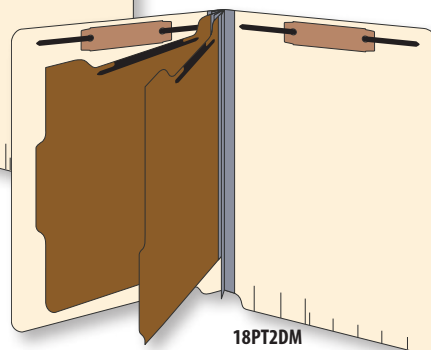

18PT2DM  
18pt Manila

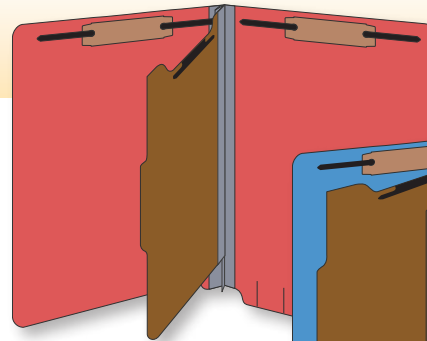

20PT1DR  
20pt Colored Stock

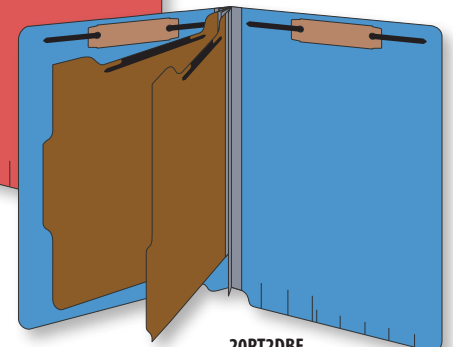

20PT2DBE  
20pt Colored Stock

Item #	Expansion	Paper Weight	Qty per box	Lb / 1,000
18PT1DM	2" gray	18pt	15	185
18PT2DM	2" gray	18pt	10	235
20PT1D + color	2" gray	20pt	15	200
20PT2D + color	2" gray	20pt	10	250

Specify color when ordering



## 14PT Folders with Manila Dividers

9-1/2" H x 12-1/4" W

Construction features 14pt outer folder with double-back 28pt thick dividers, 2" bonded fasteners and a 2" poly reinforced W-fold expansion.

Extra heavy dividers with 2" bonded fasteners provide the necessary rigidity to hold maximum volume of documents. Folders will not sag or bow on the shelf.

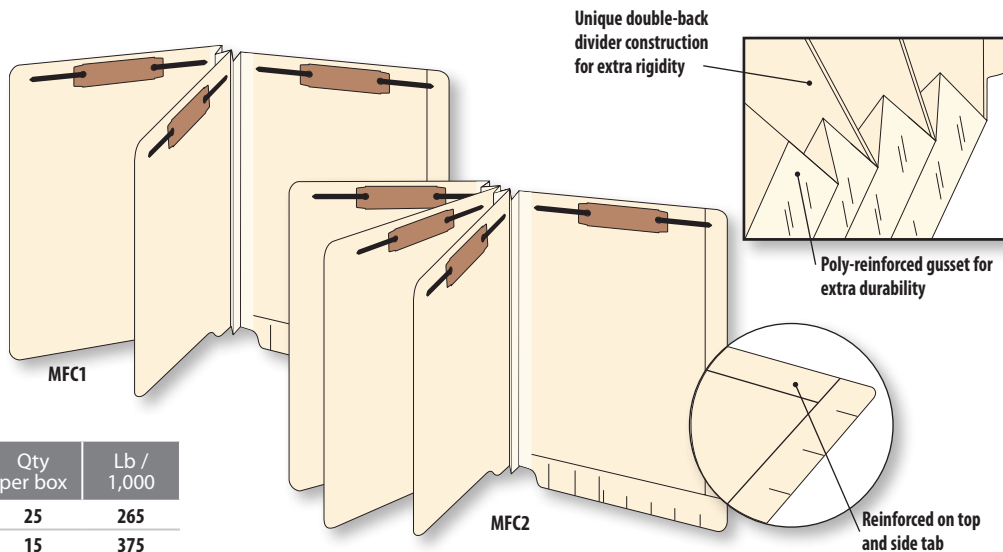

Item #	Expansion	Fasteners	Qty per box	Lb / 1,000
MFC1	2" W-fold	4 total	25	265
MFC2	3" W-fold	6 total	15	375

## 18PT Folders with Manila Dividers

9-1/2" H x 12-1/4" W

Construction features 18pt single ply folder with Tyvek® gusset. Because of the flexible Tyvek® gusset, these folders will not bulk-up on the shelf and take up valuable space.

Tyvek® spine provides a flexible gusset and long life for active records.

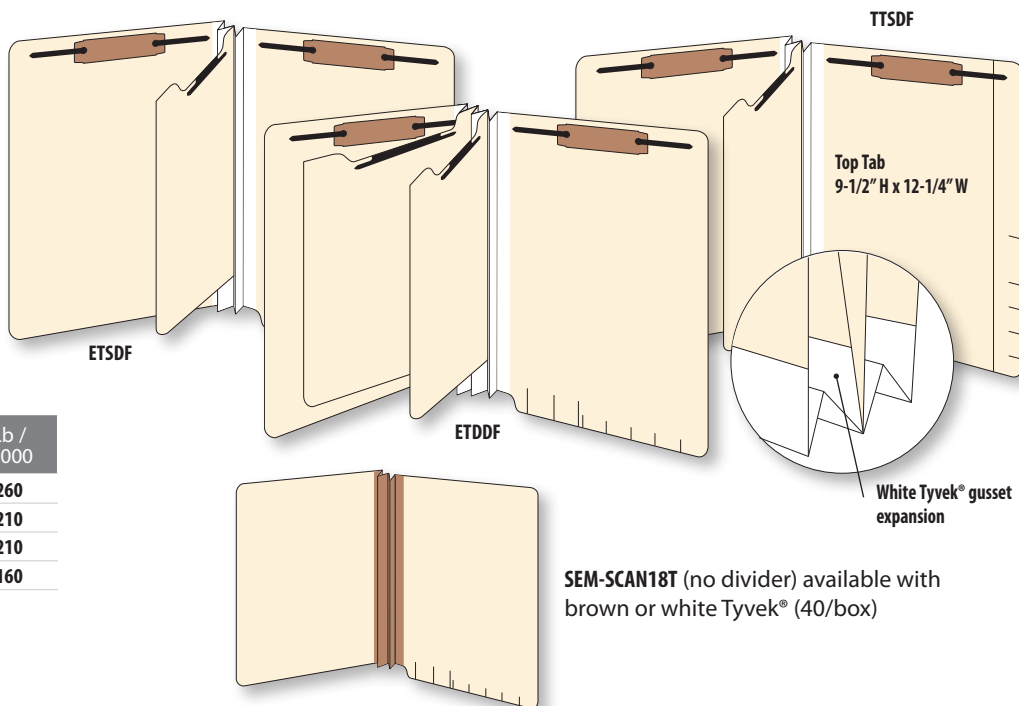

Item #	Expansion	Qty per box	Lb / 1,000
ETSDF	1-1/2"	25	260
ETDDF	1-1/2"	15	210
TTSDF	2"	20	210
SEM-SCAN18T	1-1/2"	40	160

SEM-SCAN18T (no divider) available with brown or white Tyvek® (40/box)

## Pocket Folders with Manila Dividers

**DVP113** – Unique construction and features, this 11pt folder has full outside pocket that is 12-1/4" W x 8-1/4" D and will accommodate Panorex x-rays without having to trim them. Scored label placement lines.

**MRSP1421D1** – Base single pocket folder is 14pt thick with an 11pt divider installed in position #5.

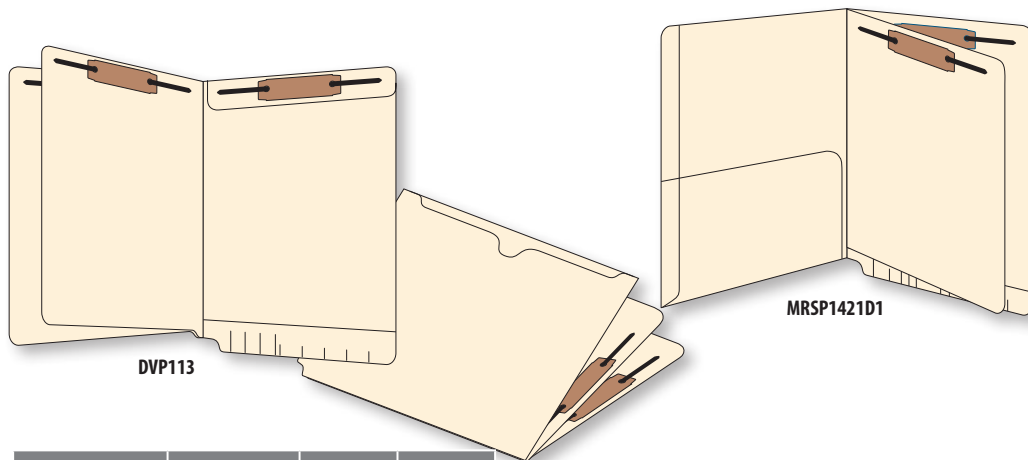

Item #	Fasteners	Qty per box	Lb / 1,000
DVP113	4 total	25	205
MRSP1421D1	3 total	25	200

# File Pockets

## AC11 & AC14 End-Tab File Pockets

9-1/2" H x 12-1/4" W – 11pt & 14pt Manila and 11pt Colors

Diagonal cut front panel allows easy access to contents. Closed on two sides to secure documents from falling out. Scored label placement marks on a double ply end-tab.

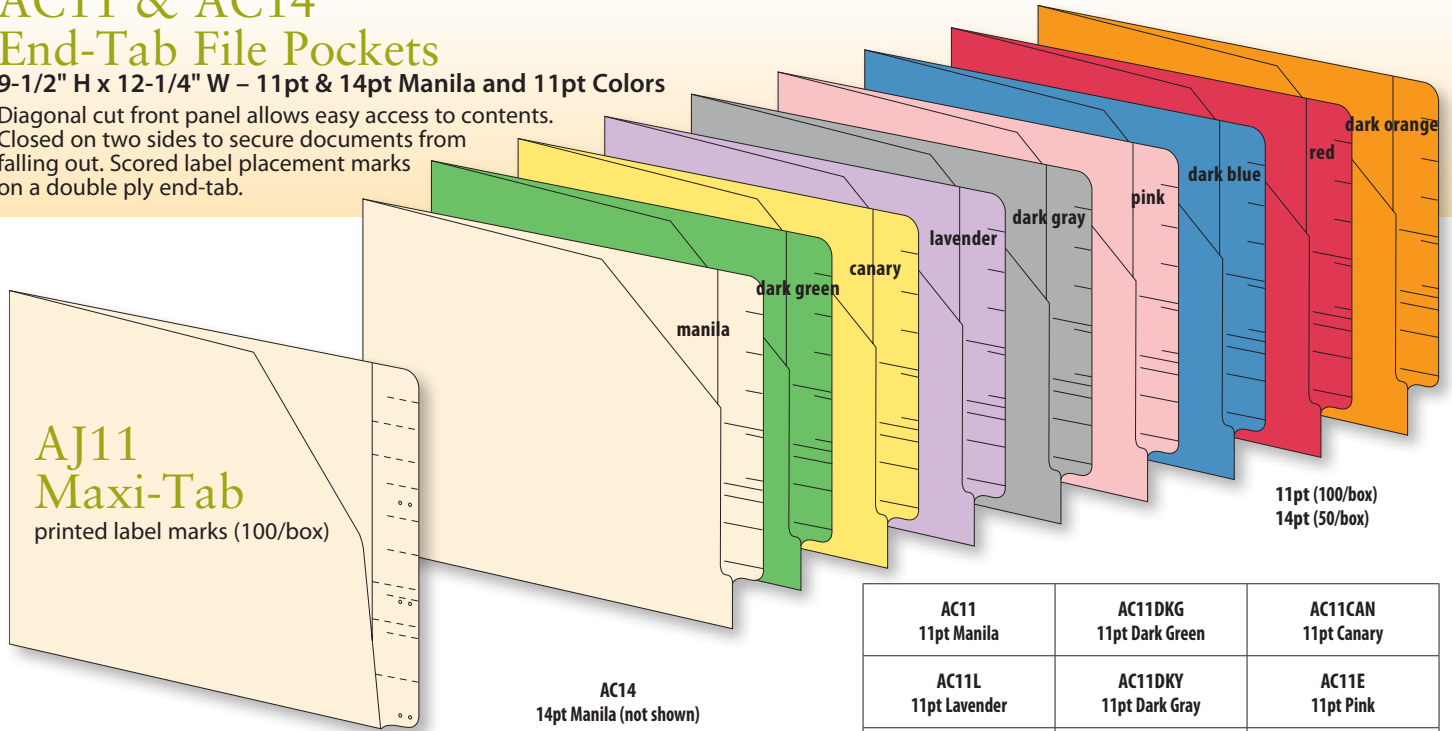

11pt (100/box)  
14pt (50/box)

AC14  
14pt Manila (not shown)

AC11 11pt Manila	AC11DKG 11pt Dark Green	AC11CAN 11pt Canary
AC11L 11pt Lavender	AC11DKY 11pt Dark Gray	AC11E 11pt Pink
AC11DKB 11pt Dark Blue	AC11D 11pt Red	AC11DKH 11pt Dark Orange

## FP12 End-Tab File Pockets

9-1/2" H x 12-1/4" W  
11pt Manila and Colors

Reinforced side seam construction with single ply top. Pockets are closed on three sides for maximum security and document protection.

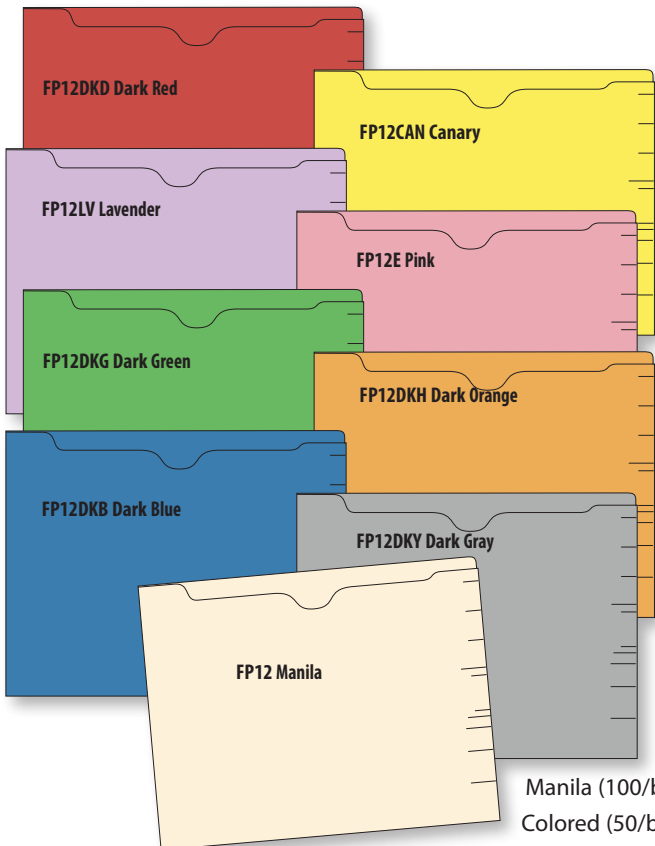

Manila (100/box)  
Colored (50/box)

## M11PK 11PT End-Tab Pockets

9-1/2" H x 12-1/4" W – Printed Color Border (100/Box)

More economical than colored stock, these manila pockets with printed borders have a double ply top and side for extra durability. Pockets have scored tab scores for easy label placement.

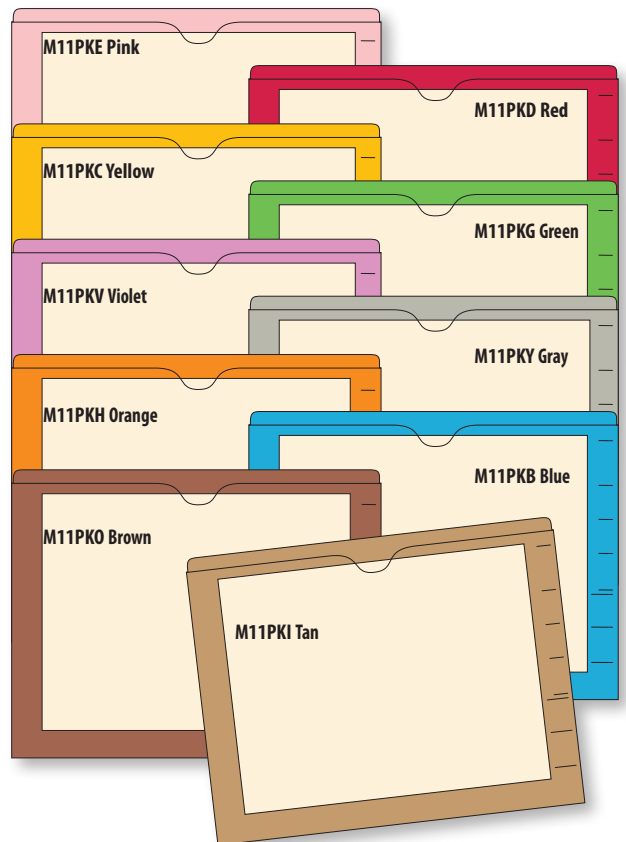

## FP11 11PT Top Tab Pockets

9-1/2" H x 11-3/4" W – Manila and Colors

Double ply tab with double recessed thumb notch allows more space for labeling and provides easier access to contents. Perfect for drawer filing when quick color references are required. (100/box)

<b>FP11DKD</b> 11pt Dk Red	<b>FP11DKG</b> 11pt Dk Green	<b>FP11L</b> 11pt Lavender
<b>FP11DKB</b> 11pt Dk Blue	<b>FP11CAN</b> 11pt Canary	<b>FP11DKY</b> 11pt Dk Gray

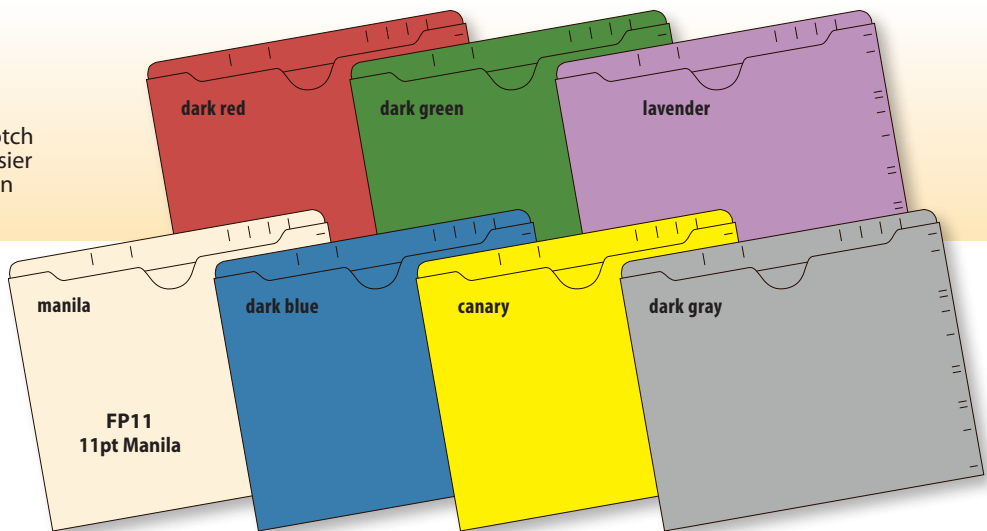

## MXP11 11 Point Expansion Pocket

9-1/2" H x 11-3/4" W – 9" H front

Double ply end tab with 1-1/2" paper gusset expansion. Ships tucked. (50/box)

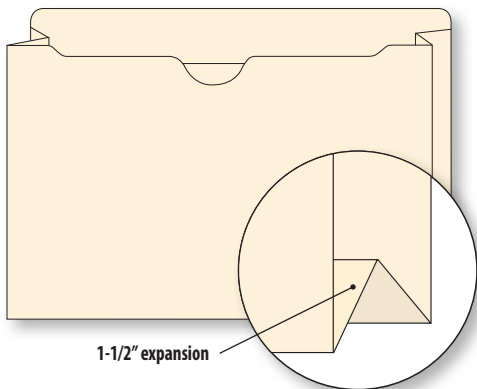

## FPDT12 11 Point Manila Pocket

9-1/2" H x 12-1/4" W

Double ply end tab with thumbcut front and 8 scored tick marks. (100/box)

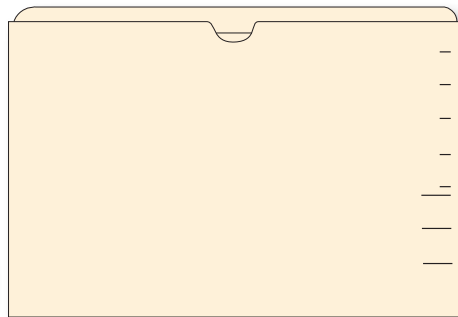

## MJP11 11 Point Mini-End Tab

6" H x 9-1/2" W – Manila

Single ply end tab designed for optical office applications or small document storage. Closed on 2 sides. (100/box)



## Economy File Envelopes

28 lb. and 32 lb. – Kraft Colors

8-3/4" H x 11-1/4" W  
Perfect filing envelopes for lightly used files. Closed on three sides. Front is printed with spaces for name, home and business phone numbers plus addresses. (100/box)

28 lb. – All colors except Kraft and Gray

32 lb. – 1071K – Kraft  
1073GY – Gray

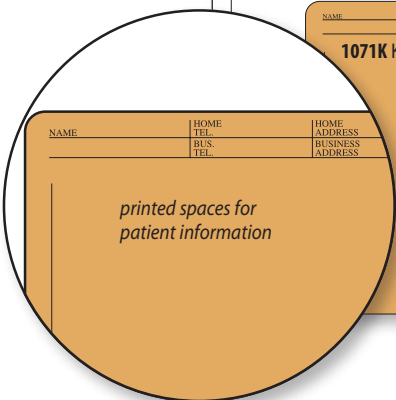
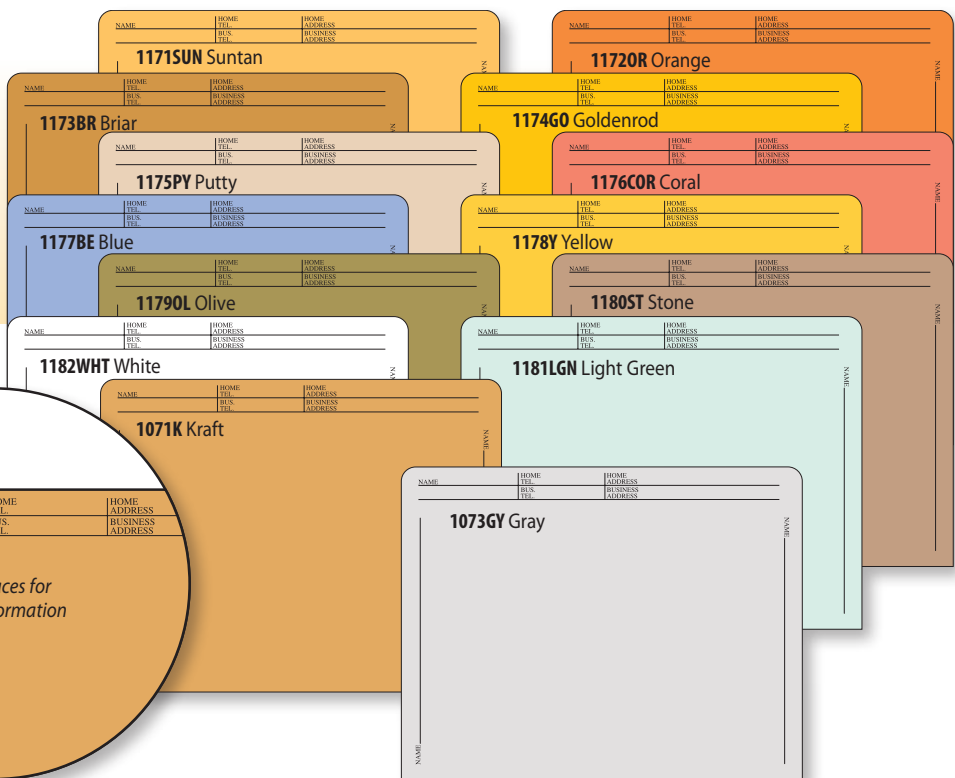

# Kardex® Comparable Folders

Choose from a wide selection of folders constructed using only the highest quality pulp dyed colored stock and designed for use in the Kardex® 10 color system.



## SEM-SCAN Numeric

Here's a highly effective terminal digit filing system that works great. It offers all the benefits of terminal digit filing with quick retrieval time.

## SEM-SCAN Alpha

This system makes straight alphabetic filing obsolete. It dramatically cuts filing and retrieval time and practically eliminates misfiles. It works extremely well for any size filing system. It's simple to learn and set up.

## SEM-SCAN Numeric

- 11pt Pulp Dyed Stock
- Overall Size: 9-1/2" X 11-3/4"
- Double-Ply Top & End Tab
- Scored for 3/4" expansion
- 0 - 9 scale printed on tab twice
- Available in 10 colors

SEM-SCAN Numeric Color Chart				
0 white	1 red	2 yellow	3 pink	4 green
5 brown	6 blue	7 orange	8 purple	9 tan

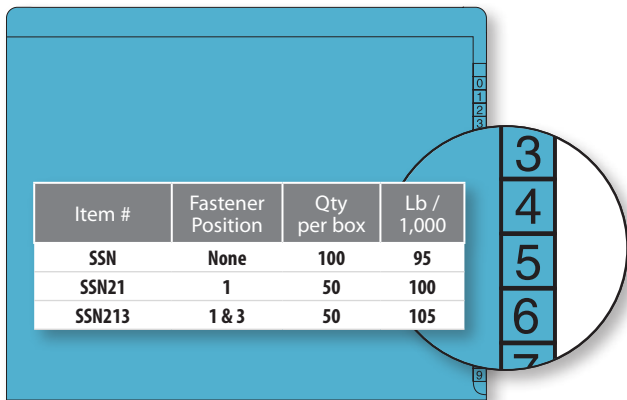

## SEM-SCAN Alpha

- 11pt Pulp Dyed Stock
- Overall Size: 9-1/2" X 11-3/4"
- Double-Ply Top & End Tab
- Scored for 3/4" expansion
- A - Z scale printed on tab
- Available in 10 colors

SEM-SCAN Alpha Color Chart				
AB red	C yellow	DEF pink	GHI green	J white
KL brown	MNO blue	PQR orange	ST purple	U-Z tan

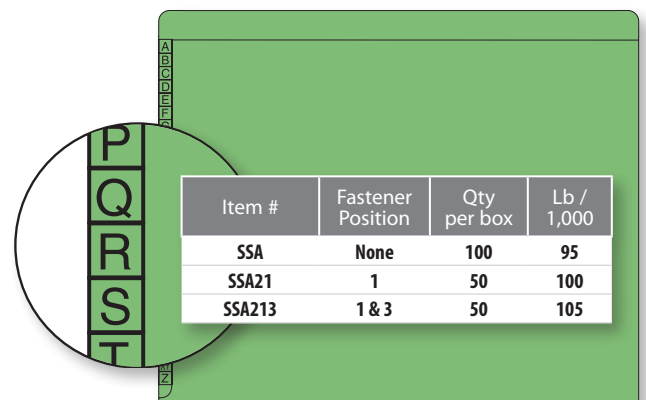

## CT100

- 11pt Pulp Dyed Stock
- Overall Size: 9-1/2" X 11-3/4"
- Straight Cut 2-Ply Top Tab
- Available in 10 colors

white	blue
yellow	red
pink	green
orange	tan
brown	purple



Item #	Fastener Position	Qty per box	Lb / 1,000
CT100	None	100	95
CT10021	1	50	100
CT100213	1 & 3	50	105

## SEM-SCAN 10

- 11pt Pulp Dyed Stock
- Overall Size: 9-1/2" X 12-1/4"
- Double-Ply Top & End Tab
- Scored for 3/4" expansion
- Available in 12 colors

white	blue
yellow	red
dark blue	pink
green	orange
tan	brown
purple	gray

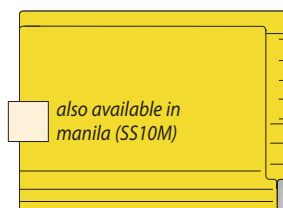

Item #	Fastener Position	Qty per box	Lb / 1,000
SS10	None	100	100
SS1021	1	50	105
SS10213	1 & 3	50	110

## SEM-SCAN 20

- 20pt Pulp Dyed Stock
- Overall Size: 9-1/2" X 12-1/4"
- Single-Ply End Tab
- Scored for 3/4" expansion
- Available in 12 colors

white	blue
yellow	red
dark blue	pink
green	orange
tan	brown
purple	gray



Item #	Fastener Position	Qty per box	Lb / 1,000
SS20	None	40	150
SS2021	1	40	155
SS20213	1 & 3	40	160

## SEM-SCAN 20T

9-1/2" x 12-1/4"

- 20pt Pulp Dyed Stock
- Single-Ply End Tab
- 1-1/2" Tyvek expansion
- Available in 12 colors



white	yellow	dark blue	green	tan	purple
blue	red	pink	orange	brown	DISCONTINUED

Item #	Paper Weight	Fastener Position	Qty per box	Lb / 1,000
SS20T	20pt	None	50	165
SS20T21	20pt	1	50	170
SS20T213	20pt	1 & 3	50	175

## SEM-SCAN 20T Legal

9-1/2" x 15-1/4"

- 20pt Pulp Dyed Stock
- Single-Ply End Tab
- 1-1/2" Tyvek expansion
- Available in 12 colors



white	yellow	dark blue	green	tan	purple
blue	red	pink	orange	brown	DISCONTINUED

Item #	Paper Weight	Fastener Position	Qty per box	Lb / 1,000
SS20TL	20pt	None	50	200
SS20TL21	20pt	1	50	215
SS20TL213	20pt	1 & 3	50	220

## SEM-SCAN 20T Numeric

9-1/2" x 12-1/4"

- 20pt Pulp Dyed Stock
- Single-Ply End Tab
- 1-1/2" Tyvek expansion
- 0 - 9 scale printed on tab
- Available in 10 colors

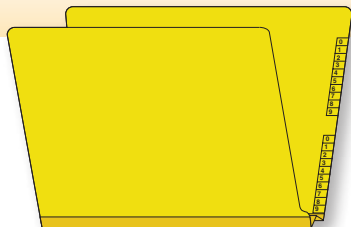

white	red	yellow	pink	green
brown	blue	orange	purple	tan

Item #	Paper Weight	Fastener Position	Qty per box	Lb / 1,000
SS20TN	20pt	None	50	165
SS20TN21	20pt	1	50	170
SS20TN213	20pt	1 & 3	50	175

## SEM-SCAN 20T Numeric Legal

9-1/2" x 14-3/4"

- 20pt Pulp Dyed Stock
- Single-Ply End Tab
- 1-1/2" Tyvek expansion
- 0 - 9 scale printed on tab
- Available in 10 colors

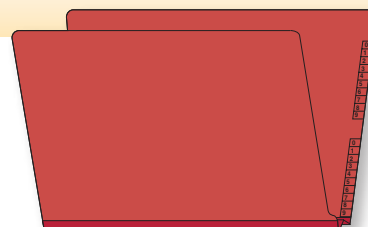

white	red	yellow	pink	green
brown	blue	orange	purple	tan

Item #	Paper Weight	Fastener Position	Qty per box	Lb / 1,000
SS20TNL	20pt	None	50	200
SS20TNL21	20pt	1	50	215
SS20TNL213	20pt	1 & 3	50	220

## SEM-SCAN 20T Alpha

9-1/2" x 12-1/4"

- 20pt Pulp Dyed Stock
- Single-Ply End Tab
- 1-1/2" Tyvek expansion
- A - Z scale printed on tab
- Available in 10 colors



red	yellow	pink	green	white
brown	blue	orange	purple	tan

Item #	Paper Weight	Fastener Position	Qty per box	Lb / 1,000
SS20TA	20pt	None	50	165
SS20TA21	20pt	1	50	170
SS20TA213	20pt	1 & 3	50	175

## SEM-SCAN 20T Alpha Legal

9-1/2" x 14-3/4"

- 20pt Pulp Dyed Stock
- Single-Ply End Tab
- 1-1/2" Tyvek expansion
- A - Z scale printed on tab
- Available in 10 colors

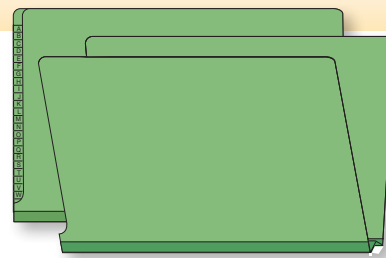

red	yellow	pink	green	white
brown	blue	orange	purple	tan

Item #	Paper Weight	Fastener Position	Qty per box	Lb / 1,000
SS20TAL	20pt	None	50	200
SS20TAL21	20pt	1	50	215
SS20TAL213	20pt	1 & 3	50	220

# Pressboard & Specialty Filing

## Pressboard

Great for presentation and durability, pressboard folders are manufactured using only the highest quality pressboard and can be customized with a wide range of color, divider, and expansion options.



**Type I Genuine Pressboard™** - is a durable recycled pulpboard pressed together to produce 20pt pressboard. It is one of the most durable materials in the industry for making filing products. Type I Genuine Pressboard is used for folders, classification folders and guides, and color coding files.

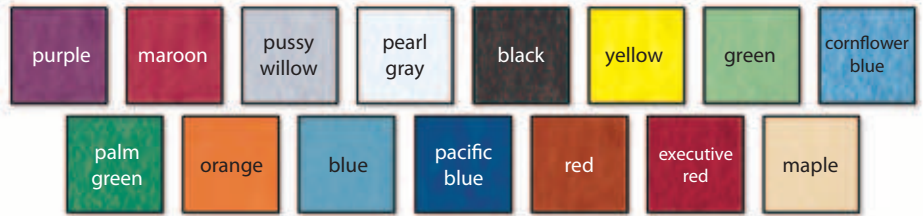

**Type II Guidex® Pressboard** - is a durable recycled pulpboard pressed together to produce 25pt pressboard. Type II Guidex® Pressboard is one of the most durable materials in the industry for filing products.



**Type III Valtex™ Pressboard** - is a relatively low grade 25pt recycled pressboard. It is an economical alternative to Type II Guidex™ Pressboard.



Type I Genuine Pressboard™ and Type II Guidex® Pressboard are registered trademarks of FiberMark



**Tyvek®** - is extremely tear-resistant and has a superior shelf life. This material is used to form the expansion (gusset) for pressboard folders. New Brown and Dove Gray Tyvek® are stocked in the most popular expansion sizes. Colors listed below are available when purchased in minimum quantities. Colors are subject to change.



Catalog color charts are not exact representations of actual products. Contact us for samples or swatches.

## Laminated End-Tab Folders made of DuPont™ Tyvek®

**Sleek & Stylish. High performance 14pt reinforced end-tab folder featuring DuPont™ Tyvek® – a tough sharkskin textured laminate engineered to add strength and durability without adding bulk.**

**Efficient & Economical. This durable, cost effective, space saving folder can be customized to suit your needs by adding fasteners, dividers, printing and more.**



- Scored spine for 3/4" expansion
- Scored tick marks on end-tab for easy label application
- Outstanding moisture, chemical, mold and dirt resistance
- Ideal for lab applications
- Available in Manila, Green, Yellow, Blue & Red
- Packed 20/box

Item #	Color	Fastener Position	Item #	Color	Fastener Position
TVKMMRS20	Manila	None	TVKGMRS20	Green	None
TVKMMRS2021	Manila	1	TVKGMRS2021	Green	1
TVKMMRS20213	Manila	1 & 3	TVKGMRS213	Green	1&3
TVKDMRS20	Red	None	TVKBMRS20	Blue	None
TVKDMRS2021	Red	1	TVKBMRS2021	Blue	1
TVKDMRS20213	Red	1&3	TVKBMRS20213	Blue	1&3
TVKCMRS20	Yellow				
TVKCMRS2021	Yellow				
TVKCMRS20213	Yellow				

Available Colors		
manila	red	yellow
blue	green	

## 5 Piece Expansion Pockets

**Great for presentation, organization, and longevity.**

Expansion pockets are made from quality recyclable red wallet, gray wallet or manila stock and laminated for a sturdy finish. Each expanding pocket is a 5-piece construction. Tear-proof Tyvek® is used on gussets, protecting the most wear-prone points and edges for lasting use (other colors are available upon request).

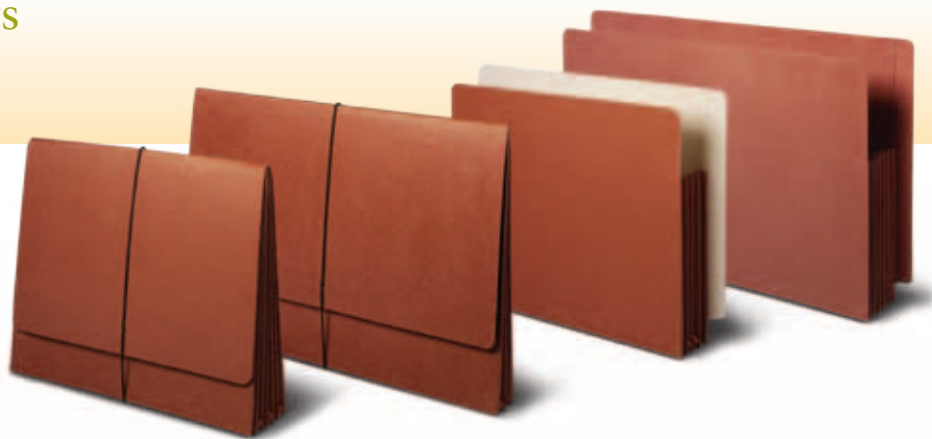

All products can be imprinted with name, logo or product information for coding and filing purposes. Rivets can be added in gusset locations for added durability and strength. Additional sizes and paper stocks are available.



# centerpoint

## FILING SYSTEM

**NEW**

### DISTINCTIVE ORGANIZATION

The centerpoint hanging filing system provides the ultimate in organization combined with the benefits of open shelf filing. Convenient lateral access allows clear identification and quick retrieval.



### DISTINGUISHABLE BENEFITS

- Perfect for file conversions
- Continuous filing capabilities
- Fronts of files hang straight & clean
- One handed retrieval
- Acid free kraft cardboard
- Flexible for different types of media





## Gusseted End Tab File

8-1/2" x 11" capacity 1-1/4" expansion

Single gusset files act as a "vertical bin" for sliding documents in and out without removing the file. Great for mail sorting and quick and easy top-tab to side tab conversions

**9508902** Box/100 Blue - Collective File

**9508907** Box/100 Gray - Collective File

**9508951** Box/100 Red- Collective File

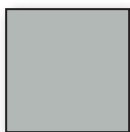

## Hanging File w/ MediClip

This lettersize file has a 1" capacity and is available in the color gray. The MediClip is woven into the spine for added strength. You can leaf through documents like a book and make a clean copy without removing pages from the file.

**9505907** Box/100 Folders with MediClip in position 5 (Gray)

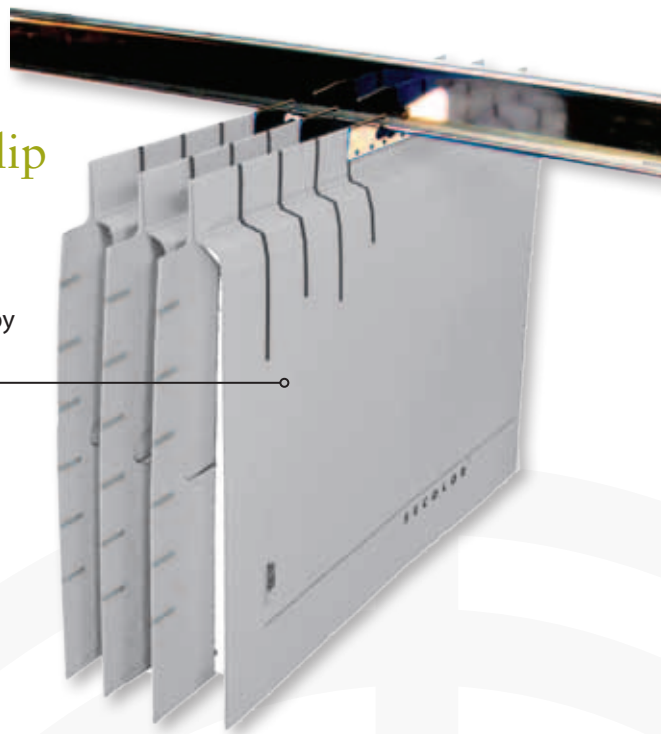

## Shelving Unit

Shelving unit w/ 7 bar assemblies (sand)  
Includes all components necessary for a seven level cabinet.

**DATCENT** - Unit measures: 36" W x 15" D x 97" H

## Bar Assembly Only

The Bar Assembly is inserted into any standard 4 post shelving units. It is possible to place 7 units into a 97" high shelving unit. It is possible to mix and match shelves and bar assemblies to match different media types.

**BA3612** - Bar Assembly unit for standard 4 post shelving 36"W x 15"D

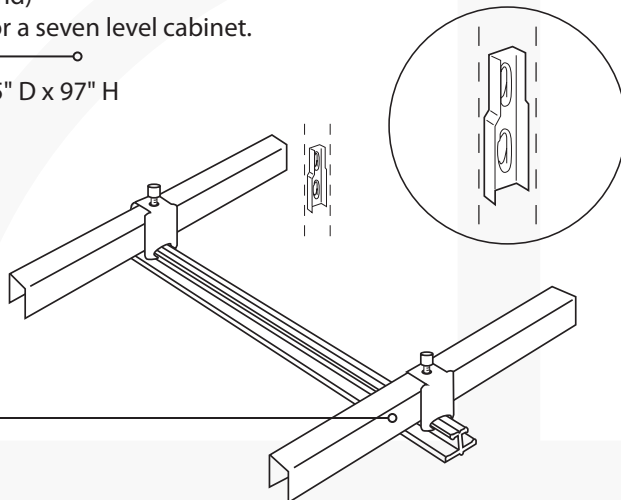

# Fasteners and Accessories

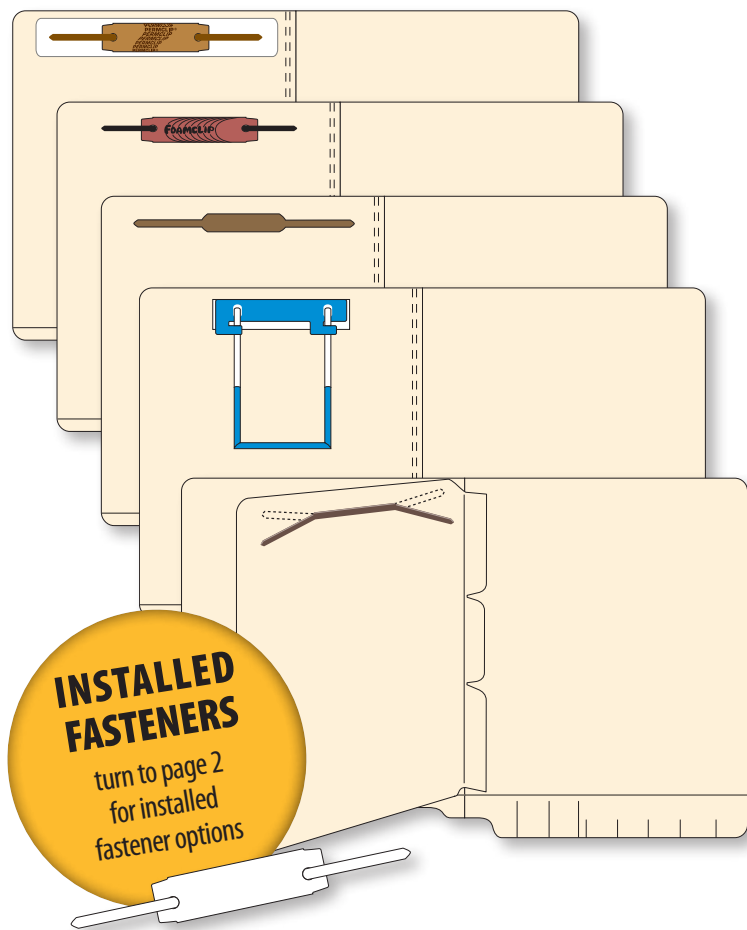

### Self-Adhesive Sem-Clip (#2912)

A 2" capacity self-adhesive bonded on self-adhesive label backing per strip. Easy to position and apply. 100 clips per package (4 strips per sheet, 25 sheets per package).

### Foam Clip (#2914)

A 1-1/2" capacity foam clip fastener is designed for heavy-duty use with an extra-strong adhesive foam backer. Packed 100/Box.

### 1ABF or 2ABF

Self-adhesive metal fastener has two methods of application. Insert prongs through die-cut slits from outside of folder for bulky records, or mount inside with adhesive base. Easy-to-use location template included. Packed 100 / Box.

### MediClip / DocuClip (#2913)

This unique 5" capacity fastener converts any file folder into a ring binder, loose-leaf format. The flexible 3-piece construction attaches in seconds to any type of file folder. Sold 100 / Box.

### Duo Clip (#2915)

Insert the prongs through slits in the divider (like our self-adhesive divider), fold back one side of the prong to make a secure fastener for both sides of the divider. The fastener positioned this way will have a 1" capacity on one side of the dividers and 5/8" on the other. Sold 100 per box.



### Conversion Flaps (#CONVFLAP)

Convert standard style indexes into fileback style dividers. Works with any fastener with 2-3/4" center-to-center holes. (50/box)



### U-File-M (#U-FILE-M)

Make each folder read like a book. Records are affixed to tabs of strip in either ascending or descending order. Oldest information can always be on the top or newest information will always be on the top. (100/box)



### MediStrip (#DOCUSET)

Adding a MediStrip saves additional space by doing away with the compressor and allows for easier viewing, insertion or deletion of material. It allows file dividers and pages to turn easily and lie flat, similar to a ring binder. You can easily add and remove pages by separating the extension piece and the tube base. (100/pkg)



### Reinforcing Strips (#7551RS)

Add durability to important documents that are mounted within charts; or repair any ripped 2-hole punches. Strips are clear, self-adhesive, 31-1/16" W pre-punched with 1/4" holes on 2-3/4" center-to-center. (500/box)



## DigiStrip

YOUR PHYSICAL AND DIGITAL INFORMATION TOGETHER IN ONE FILE!

The DigiStrip is a USB flash drive fastener attachment that makes it possible to store all corresponding digital files with the physical records.

- Perfect for storing presentations, images, & video
- Ideal for real estate agents, lawyers, & designers
- No more lost USB flash drives
- Available with either 2GB or 4GB capacity



digi2gb

digi4gb

safely secures onto fastener prongs



## Bottom Tab Outguides

Body 9-1/2" x 11-7/8", Overall 9-1/2" x 13"

Angle cut pocket and thumb-notched charge-out slip pocket.

Double sided "OUT" tab on bottom.

- OG4814R Red
- OG4813P Purple
- OG4810BK Black
- OG4811OR Orange
- OG4812PK Pink
- OG4817Y Yellow
- OG4803LBE Light Blue
- OG4807G Green
- OG4808L Lavender
- OG4801BE Blue
- OG4800CL Clear



## Bottom Tab Outguides

Body 9-1/2" x 11-7/8", Overall 9-1/2" x 13"

Straight cut top edge pocket with charge-out slip pocket.

Double sided "OUT" tab on bottom.

- OG8801BE Blue
- OG8807GN Green
- OG8808LV Lavender
- OG8811OR Orange
- OG8812PK Pink
- OG8814R Red
- OG8817Y Yellow



## Center Tab Outguides

Body 9-1/2" x 11-7/8", Overall 9-1/2" x 12-7/8"

Angle cut pocket with top charge-out slip pocket. Center placed double sided "OUT" tab.

- |                      |                |
|----------------------|----------------|
| OG7801BE Blue        | OG7812PK Pink  |
| OG7803LBE Light Blue | OG7813P Purple |
| OG7807GN Green       | OG7814R Red    |
| OG7808L Lavender     | OG7817Y Yellow |
| OG7810BK Black       | OG7802BN Brown |
| OG7811OR Orange      |                |



## Bottom Tab Outguides

Body 9-1/2" x 11-7/8", Overall 9-1/2" x 13"

Angle cut pocket with lower angle cut charge-out slip pocket.

Triple thickness single sided "OUT" tab on bottom.

- OG5814R Red
- OG5813P Purple
- OG5810BK Black
- OG5811OR Orange
- OG5812PK Pink
- OG5817Y Yellow
- OG5803LBE Light Blue
- OG5807G Green
- OG5808L Lavender
- OG5801BE Blue
- OG5800CL Clear

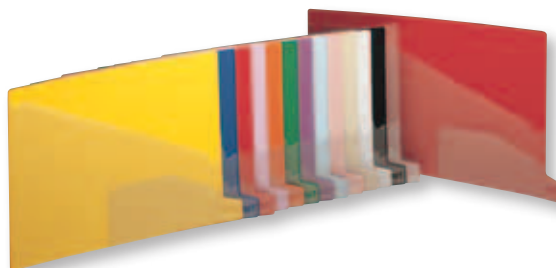

## Charge-Out Slips

These simple forms provide written records to control borrowed files. Slips are inserted into the smaller pockets of outguides. (500/pkg)

FILE NUMBER	FILE I.D. NUMBER
FILE NAME	
CHARGE TO	DEPARTMENT
DATE CHARGED	FOLLOW-UP DATE
DESCRIPTION OF FILES REMOVED <input type="checkbox"/> ENTIRE FILE REMOVED	
DESCRIPTION OF FILES REMOVED <input type="checkbox"/> ENTIRE FILE REMOVED	

7800C0

## Confidential Carrier

Durable carriers hold up to 4 inches of files when expanded Nylon zipper Super-strong Armor Shell material is washable and waterproof - made to be used over and over again Size: 16-1/2x12-1/2"

- |              |              |
|--------------|--------------|
| 26970 Red    | 26971 Orange |
| 26972 Yellow | 26973 Blue   |



## Magabinderbe

2" H x 10" W

Keep magazines looking like new! Features extra-heavy, flexible vinyl front and dark blue vinyl back. 3-ring steel backbone with spring-loaded closure allows quick changing of magazines. Holds magazines up to 11-1/4"H x 9-1/2"W Color : Blue 1.08 lbs. per Each



## End Tab Converters

End Tab Converters are a quick and economical alternative to replacing entire file folders. The self-adhesive strip adheres to both the front and back of the folder. (500/pkg)

- ETC9165 White Full End Tab
- ETC9150 White 8" End Tab
- ETC9150M Manila 8" End Tab

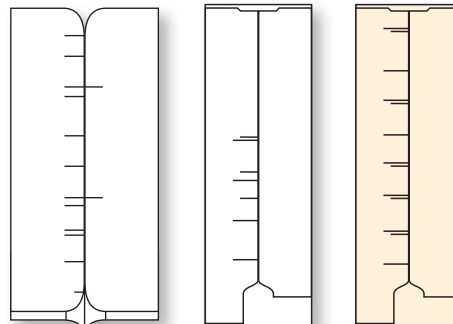

ETC9165

ETC9150

ETC9150

# Folder Pockets

## Manila & Kraft Pockets

Stock No.	Description	Size	Pack
DP11	11pt Manila Double Pocket	Back: 8-1/2" x 9" and Front: 5" x 9"	100/Carton
4024	11pt Manila Single Pocket	Overall Size: 5" x 8-3/4"	100/Carton
4021	11pt Manila Single Pocket	Overall Size: 5" x 9-1/4"	100/Carton
FE69T	32lb Kraft Envelope	Overall Size: 9" x 6"	100/Carton
FE96S	32lb Kraft Envelope	Overall Size: 6" x 9"	100/Carton
FE85	28lb Kraft Envelope	Overall Size: 5" x 8-1/8"	100/Carton
FE64	28lb Kraft Envelope	Overall Size: 4" x 6-1/8"	100/Carton

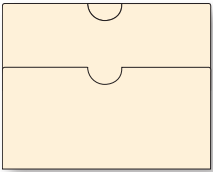
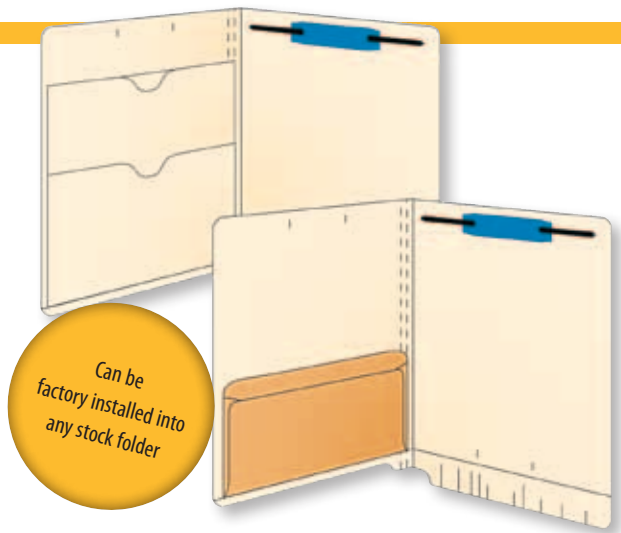

DP11

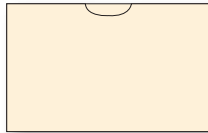

4024

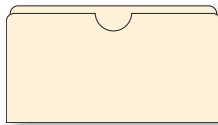

4021



FE85

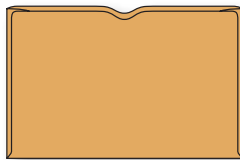

FE96S

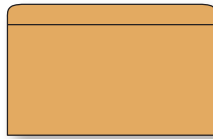

FE64



FE69T

### XR35

2-1/4" H x 3-1/2" W  
Dental x-ray envelope to store bite plates. (500 / box)

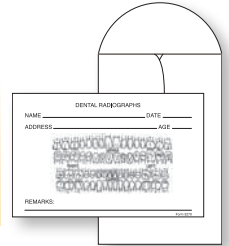

## Self-Adhesive 11pt Manila Pockets

Whenever you need to add a pocket or fill in while factory is installing your order these are a great solution.

SAP8555: 8-3/4" W x 5-1/2" H  
SAP1175: 11-1/2" W x 7-1/2" H

Unique single ply construction with self-adhesive flaps creates less bulk

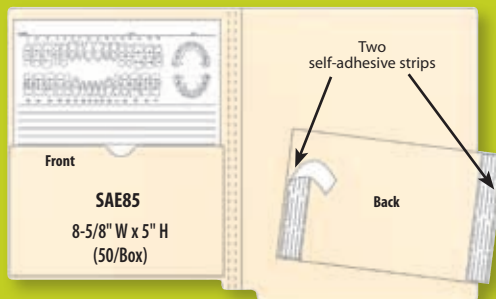

11pt manila single pocket

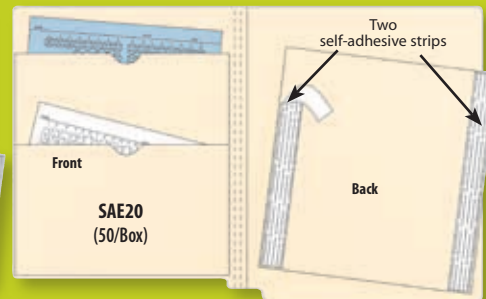

11pt manila double pocket

Back pocket: 9" W x 8-1/2" H  
Front pocket: 9" W x 5" H



Fold edges under, peel off backing and adhere to folder.

# Folder Pockets

## Self-adhesive Vinyl and Poly Pockets

Choose from several sizes of poly pockets to fit your needs. Ideal for:

- Lab reports
- Film
- ID cards
- Phone messages
- Script duplicates
- Any small document

Peel off the backing paper and apply to your patient charts or wherever it is most convenient for your use.

### 6 Mil Vinyl

Pockets are heavy-duty vinyl that resists punctures and tears

### 5 Mil Poly

Pockets are an economical choice for storing loose items like notes, X-rays, etc.

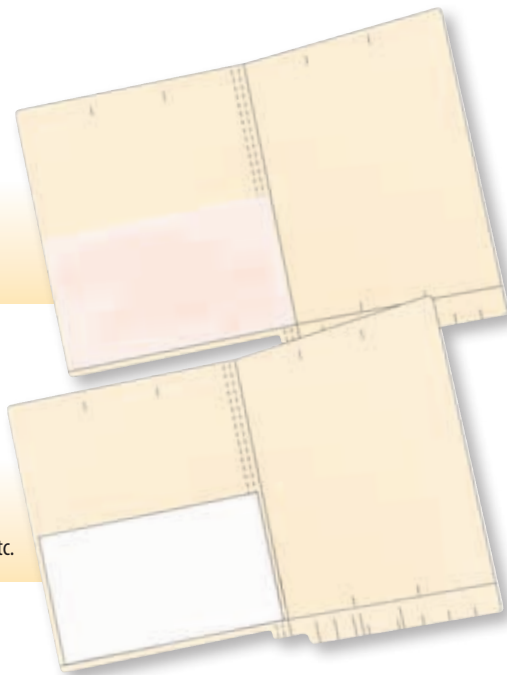

First Dimension is the side which is open.

Stock No. Overall Size Inside Dimension

#### 5 Mil Poly Pockets

7200S	2 <sup>5</sup> / <sub>8</sub> " x 4 <sup>1</sup> / <sub>16</sub> "	2 <sup>1</sup> / <sub>8</sub> " x 3 <sup>1</sup> / <sub>4</sub> "
7205S	2 <sup>3</sup> / <sub>4</sub> " x 3 <sup>5</sup> / <sub>8</sub> "	2 <sup>3</sup> / <sub>8</sub> " x 2 <sup>15</sup> / <sub>16</sub> "
7210S	3 <sup>1</sup> / <sub>8</sub> " x 4"	2 <sup>1</sup> / <sub>2</sub> " x 3 <sup>1</sup> / <sub>4</sub> "
7230S	4 <sup>1</sup> / <sub>4</sub> " x 8"	3 <sup>3</sup> / <sub>4</sub> " x 7 <sup>1</sup> / <sub>4</sub> "
7220S	4 <sup>1</sup> / <sub>2</sub> " x 5 <sup>9</sup> / <sub>16</sub> "	4 <sup>1</sup> / <sub>8</sub> " x 4 <sup>3</sup> / <sub>4</sub> "
7240S	5" x 7 <sup>1</sup> / <sub>4</sub> "	4 <sup>1</sup> / <sub>2</sub> " x 6 <sup>1</sup> / <sub>2</sub> "
7215S	5 <sup>1</sup> / <sub>2</sub> " x 3 <sup>1</sup> / <sub>4</sub> "	5" x 2 <sup>1</sup> / <sub>2</sub> "
7225S	5 <sup>3</sup> / <sub>4</sub> " x 3 <sup>3</sup> / <sub>4</sub> "	5 <sup>3</sup> / <sub>16</sub> " x 3"
PD64	7" x 5"	6 <sup>1</sup> / <sub>2</sub> " x 4 <sup>1</sup> / <sub>4</sub> "
7250S	9 <sup>1</sup> / <sub>4</sub> " x 6"	8 <sup>3</sup> / <sub>4</sub> " x 5 <sup>1</sup> / <sub>4</sub> "
7260S	11" x 8 <sup>3</sup> / <sub>4</sub> "	10 <sup>1</sup> / <sub>2</sub> " x 8"
7255S	11 <sup>1</sup> / <sub>16</sub> " x 9 <sup>5</sup> / <sub>16</sub> "	10 <sup>3</sup> / <sub>4</sub> " x 8 <sup>3</sup> / <sub>4</sub> "

#### 6 Mil Vinyl Pockets

VP53SA	5 <sup>3</sup> / <sub>8</sub> " x 3 <sup>5</sup> / <sub>8</sub> "	5 <sup>1</sup> / <sub>8</sub> " x 3"
VP64SA	6 <sup>3</sup> / <sub>8</sub> " x 4 <sup>1</sup> / <sub>2</sub> "	6 <sup>1</sup> / <sub>8</sub> " x 3 <sup>7</sup> / <sub>8</sub> "
VP85SA	9" x 5 <sup>1</sup> / <sub>2</sub> "	8 <sup>1</sup> / <sub>2</sub> " x 4 <sup>3</sup> / <sub>4</sub> "

## Lock-It Pockets (self-adhesive)

LP610SA: 6-1/2" W x 10" H

LP56SA: 5-1/2" W x 6-1/4" H

Durable, clear polyethylene ziplock style secures small documents including X-rays, photos, diskettes, CDs and more (100/Box)



## Zip-It Pockets

Secure single track closures keep out dirt and moisture. 2 mil thick and allows visual observation (100/Box)

Stock No.	Description	Size
ZIP23	Clear Front	Overall Size: 2" x 3"
ZIP34	Clear Front	Overall Size: 3" x 4"
ZIP35	Clear Front	Overall Size: 3" x 5"
ZIPW23	Writable Front	Overall Size: 2" x 3"
ZIPW35	Writable Front	Overall Size: 3" x 5"
ZIPW46	Writable Front	Overall Size: 4" x 6"



# INDEXES

## Features



- **Colored, reinforced mylar tabs for easy identification**
- **Bind edge reinforced holes for added durability**
- **Create tab titles for any application**
- **Custom paper stock available, call for details**

## Highlights

Custom indexes are often needed to organize documents that reside within a file folder or divide sections within a binder. Indexes allow documents and subject matter to be located and referenced instantaneously allowing retrieval of information to be hassle-free. Reinforced index tabs are available in 16 standard tab colors, with special neon colors also available (call for details). Custom indexes are available in a variety of different tab lengths and widths and can have printing applied to both the front and back of the tab. Body copy is also available (some limitations apply, call for details).



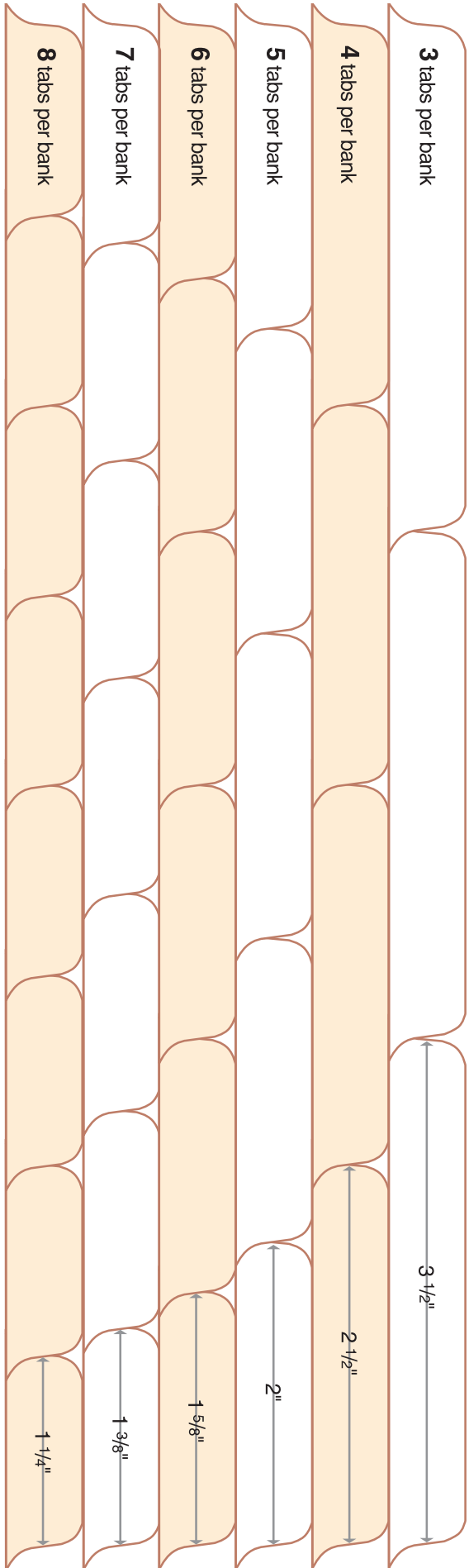

Position #1 starts at the top. Tabs shown actual size. (Plan ahead! Consider leaving an empty position for future use.)

## Easy Ordering Instructions

- 1 Choose the style of Chart Divider and Paper Color**
  - Index Style A-E and Stock Color
  - Fileback Style I-III
  - Self-Adhesive Fileback Style - SA
- 2 Specify tab cut size. See charts at left and below right. (Plan ahead! Consider leaving an empty position for future use.)**
- 3 Specify each tab title (text), position and color. (Side tab styles start at the top and bottom tab styles start at the left.)**
- 4 Specify packaging:**
  - Collated - Titles boxed together in sets (File-backs are loose, not attached to each other)
  - Not collated - Titles boxed individually



### INDEX/CHART DIVIDERS/STYLES A-E

- 90 lb. or 110 lb. White or Ivory Stock
- Mylar Reinforced Punches
- Tabs Printed Both Sides/Mylar Covered
- 8-1/2" x 11"+ (Side Tabs - 1/2" — Bottom Tabs - 3/8" or 1/2")



### SELF-ADHESIVE FILEBACKS/STYLE SA

- 110 lb. Ivory Index (Manila) Stock
- 1" Scored Hinge With 3/4" Pressure Sensitive Tape
- Two Pre-installed 2" Bonded Fasteners (1 Each Side)
- Tabs Print Both Sides w/Different Titles/Mylar Covered
- 8-1/2" x 11"+ (Side Tabs - 1/2")

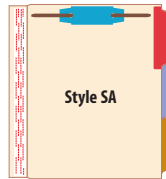

### FLIP UP HINGED FILEBACKS/STYLES I-III

- 110 lb. Ivory Index (Manila) Stock
- 1" Scored Hinge With Mylar Reinforced Slits
- One Pre-installed 2" Bonded Fastener
- Tabs Print Both Sides/Mylar Covered
- 8 1/2" x 11"+ (Side Tabs - 1/2" — Bottom Tabs - 3/8" or 1/2")

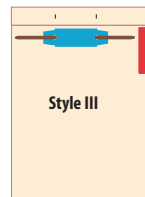
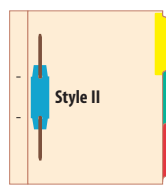

General specifications are listed above. Contact your local sales representative for other options including: body printing, collating, assembly and installation; heavier paper weights and colors, etc.

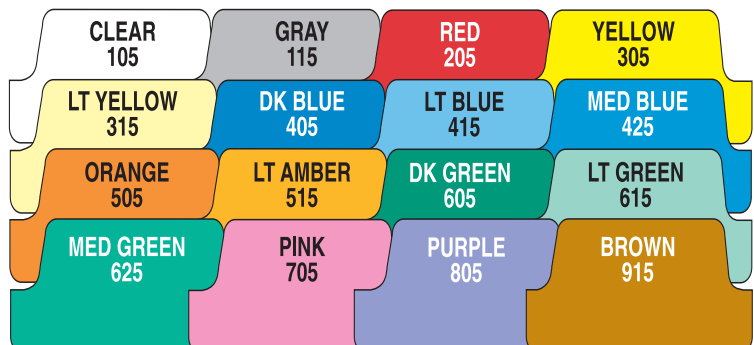

### 16 STANDARD MYLAR TAB COLORS

Neon colors available for an additional charge.

# PROVEN SOLUTIONS

Use One or All Three Styles of Dividers for Active Patient Record Organization



## Bottom and Side Tab Indexes Used With Self-Adhesive Filebacks

Maximize and divide without excessive bulk. These three styles of dividers used in conjunction with each other can provide over 20 sections in a standard folder with 3/4" expansion. Center section without fasteners allows for convenient drop-in filing.



## Dividers and Pockets Make a Perfect Chart

Small documents, papers you can't punch, active patient visits and archived information all in one chart... that's creative and efficient. For Pressure Sensitive Pockets see pages 25.

## Multi-Functional Solutions Help Organize Contents of Patient Records

Use one or all three styles of chart dividers to maximize document organization. Proven to provide a uniform and consistent method to categorize information, each style provides unique benefits.

**INDEXES** – The most common, economical style provides for multiple categories without excessive bulking in file.

**FILEBACKS** – Hinged/piggy-back style allows greater flexibility because each category can be utilized individually.

**SELF-ADHESIVE DOUBLE DUTY FILEBACKS** – Provide the same number of categories with just one half the amount of dividers because the tabs have a different title printed on each side. If ordered with a fastener installed on the front only, they can provide sections for quick, drop-in filing.

Combine the benefits of all three to create the patient chart that works best for you.



## A Great Solution for Very Active Records

Docuclip fasteners (page 23) used in conjunction with standard book style/side tab indexes provide maximum access and flexibility to all patient information. Proven to be a real workhorse.



## Combine Indexes and Filebacks Based on Document Activity

Indexes can be used to divide and categorize documents which have minimal activity or do not require active additions to each section. Filebacks used in conjunction with indexes allow more active use of sections within the chart.



## Two Styles of Filebacks Eliminates Folder Distortion

Using both flip-up style and book style filebacks provides for equalization of contents within the record. Also eliminates excessive bulking at one end of folder which allows easier filing and retrieval.

Position #1 starts at the left. Tabs are shown actual size. (Plan ahead! Consider leaving an empty position for future use or add a writeable mylar tab to the end of the set.)

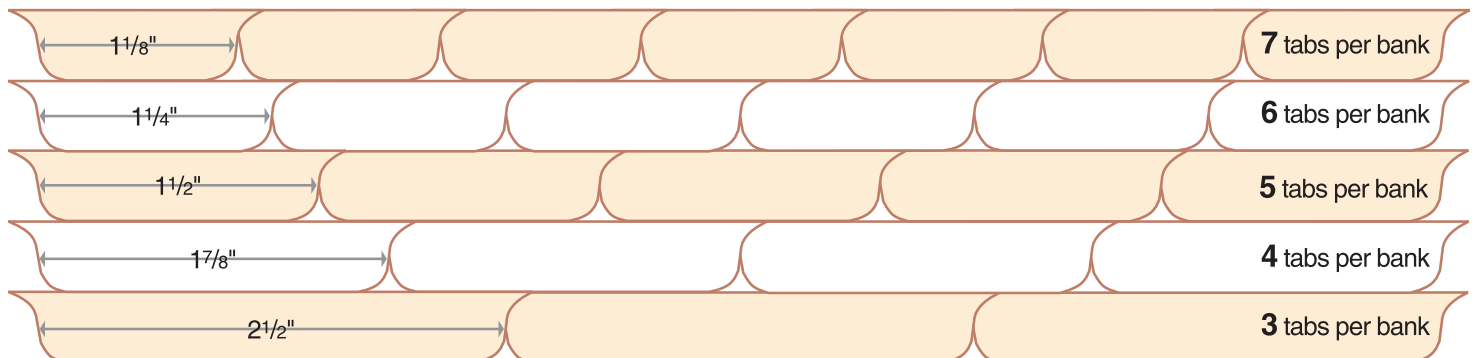



# Stock Index Chart Dividers

## Stock Bottom Tab Collated Sets

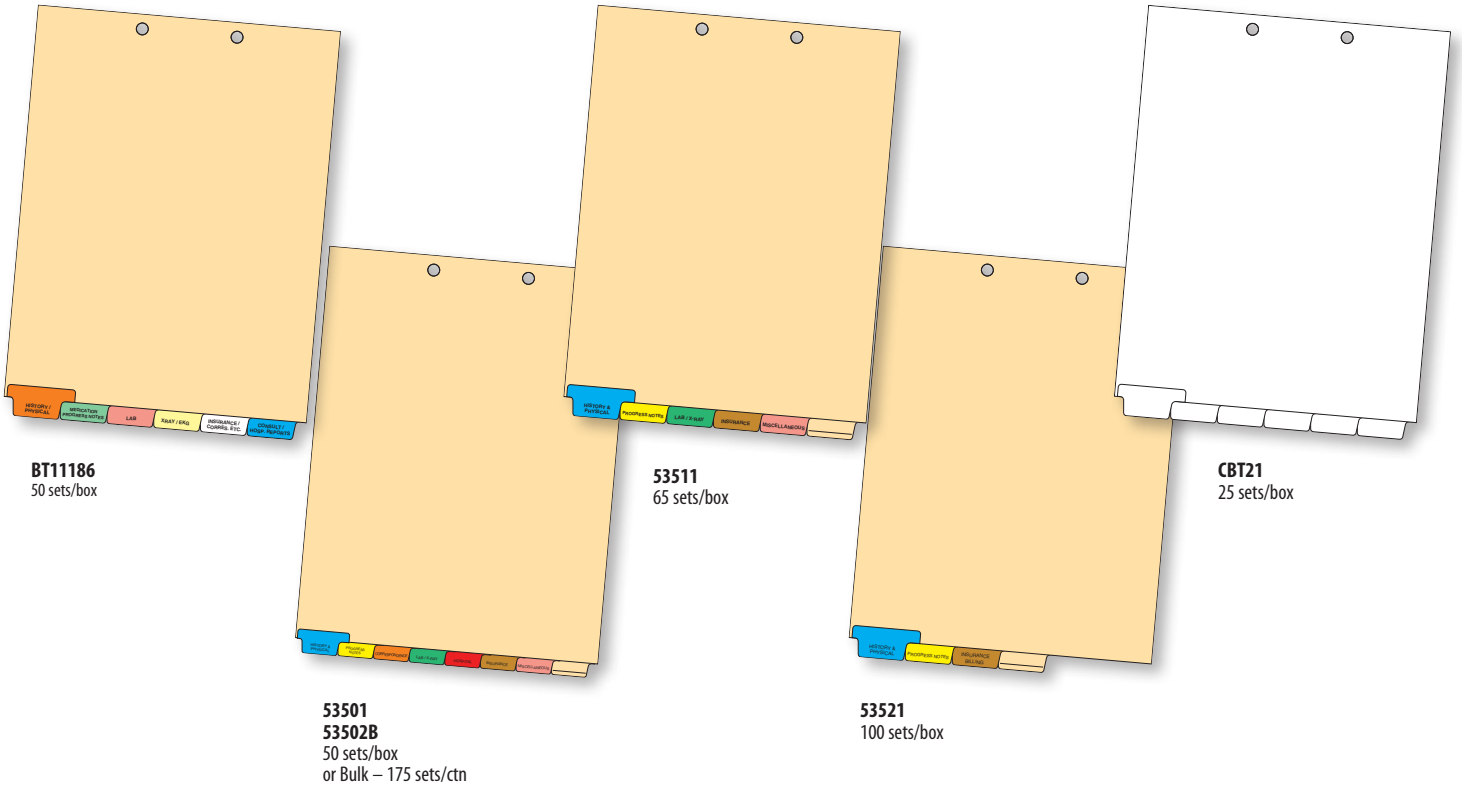

## Stock Side Tab Collated Sets

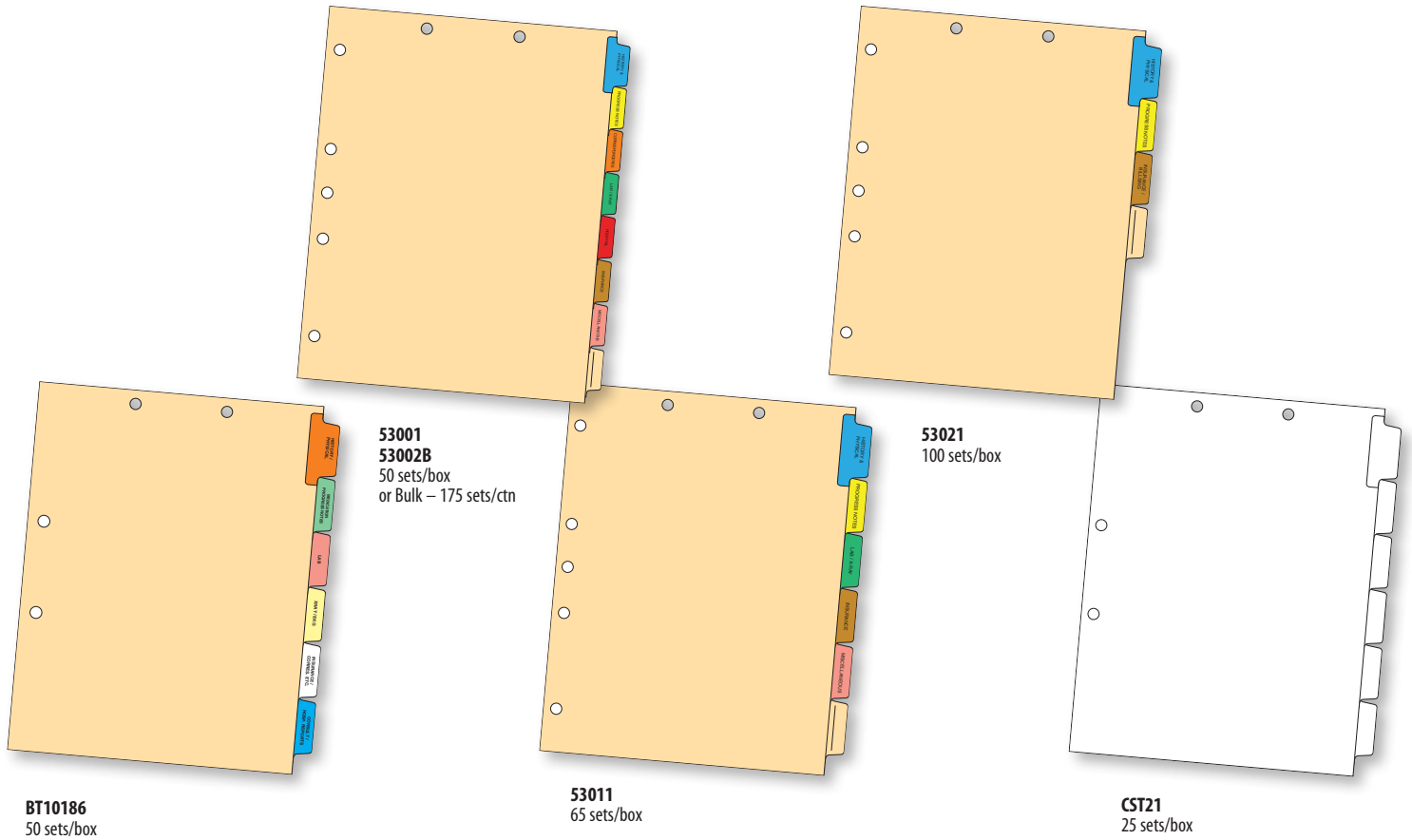

# Stock Index Chart Dividers

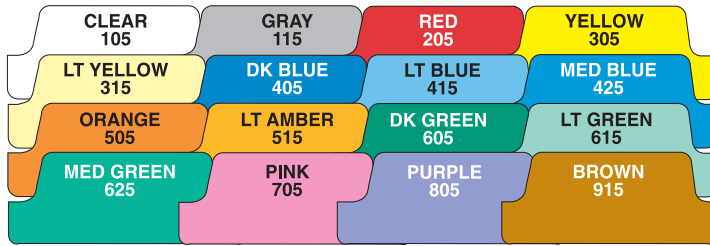

## Bottom Tab

**BOTTOM TAB STYLE WITH TITLES**  
1/6 CUT – PUNCHED TOP

### TAB POSITION 1

**History/Physical**  
52100 ■ Orange  
**Immunizations/Injections**  
52102 ■ Orange  
**Lab/Special Reports**  
52103 ■ Lt. Green  
**Paps & Colposcopy**  
52109 ■ Orange  
**Patient Information**  
52108 ■ Med. Blue  
**Progress Notes**  
52107 ■ Orange

### TAB POSITION 2

**Consents**  
52209 ■ Yellow  
**Correspondence**  
\*52204 ■ Lt. Yellow  
**Diagnostic Testing**  
52207 ■ Med. Green  
**History/Physical**  
52203 ■ Pink  
**Lab**  
52211 ■ Lt. Green  
**Medication/Progress Notes**  
52200 ■ Lt. Green  
**Prescriptions**  
52208 ■ Red  
**Progress Notes**  
52201 ■ Lt. Green  
**Surgery**  
52202 ■ Lt. Green  
**X-Rays/Scans**  
52212 ■ Lt. Amber

### TAB POSITION 3

**Lab**  
52300 ■ Pink  
**Operative Reports**  
52302 ■ Med. Blue  
**Physical Therapy**  
52308 ■ Pink  
**Physicians Orders**  
52306 ■ Lt. Amber  
**Procedures**  
52310 ■ Lt. Amber  
**Special Studies**  
52307 ■ Med. Blue

### TAB POSITION 4

**Imaging**  
52408 ■ Gray  
**Miscellaneous**  
52404 ■ Lt. Green  
**Nurses Notes**  
52406 ■ Gray  
**Pathology**  
52407 ■ Brown  
**X-Ray**  
52409 ■ Gray  
**X-Ray/EKG**  
52400 ■ Lt. Yellow

### TAB POSITION 5

**Authorization/Referrals**  
52502 □ Clear  
**Correspondence**  
52508 □ Clear  
**EKG**  
52504 ■ Red  
**Insur./Corres., Etc.**  
52500 □ Clear  
**Letters**  
52512 □ Clear  
**Miscellaneous**  
52501 □ Clear  
**Sonogram/Ultrasound**  
52513 ■ Red  
**Telephone Messages**  
52503 ■ Lt. Yellow

### TAB POSITION 6

**Consultation**  
52612 ■ Red  
**Consultation/Hosp. Reports**  
52600 ■ Med. Blue  
**Correspondence**  
52604 ■ Med. Blue  
**Flow Sheets**  
52608 ■ Gray  
**Hospital Records**  
52618 □ Clear  
**Insurance**  
52609 ■ Med. Blue  
**Medical Records**  
52606 ■ Med. Blue



## Side Tab

**SIDE TAB STYLE WITH TITLES**  
INTERCHANGABLE RIGHT/LEFT SIDE 1/6 CUT – PUNCHED TOP AND SIDE

### TAB POSITION 1

**History/Physical**  
51103 ■ Orange  
**Immunizations/Injections**  
51110 ■ Orange  
**Lab/Special Reports**  
51105 ■ Lt. Green  
**Paps & Colposcopy**  
51101 ■ Orange  
**Patient Info**  
51109 ■ Med. Blue  
**Progress Notes**  
51108 ■ Orange

### TAB POSITION 2

**Correspondence**  
51204 ■ Lt. Yellow  
**Diagnostic Testing**  
51201 ■ Lt. Green  
**Hospital Records**  
51200 ■ Lt. Green  
**Lab**  
51208 ■ Lt. Green  
**Medication/Progress**  
51202 ■ Lt. Green  
**Prescriptions**  
51206 ■ Red  
**Progress Notes**  
51203 ■ Lt. Green  
**Surgery**  
51205 ■ Lt. Green  
**X-Rays/Scans**  
51209 ■ Lt. Amber

### TAB POSITION 3

**Audiograms**  
51302 ■ Pink  
**Lab**  
51300 ■ Pink  
**Operative Reports**  
51303 ■ Med. Blue  
**Physicians Orders**  
51307 ■ Lt. Amber  
**Procedures**  
51310 ■ Lt. Amber  
**Special Studies**  
51308 ■ Med. Blue

### TAB POSITION 4

**Allergy**  
51402 ■ Lt. Yellow  
**Miscellaneous**  
51406 ■ Lt. Green  
**Pathology**  
51401 ■ Brown  
**Therapy**  
51403 ■ Purple  
**X-Ray**  
51408 ■ Gray  
**X-Ray/EKG**  
51400 ■ Lt. Yellow

### TAB POSITION 5

**Authorization/Referrals**  
51520 □ Clear  
**Correspondence**  
51510 □ Clear  
**EKG**  
51504 ■ Red  
**Financial**  
51506 ■ Lt. Green  
**Insurance/Correspondence**  
51500 □ Clear  
**Mammography**  
51502 ■ Purple  
**Miscellaneous**  
51501 ○ Clear  
**Radiology**  
51505 ■ Red  
**Telephone Messages**  
51503 ■ Lt. Yellow

### TAB POSITION 6

**Consultation**  
51618 ■ Red  
**Consult./Hosp. Reports**  
51604 ■ Med. Blue  
**Correspondence**  
51606 ■ Med. Blue  
**Hospital Records**  
51614 □ Clear  
**Insurance**  
51602 ■ Med. Blue  
**Medical Records**  
51603 ■ Med. Blue  
**OB Records**  
51600 ■ Lt. Amber  
**Other**  
51607 ■ Orange  
**Previous Medical Records**  
51601 ■ Gray

# Index Tabs and Dividers

## 400 Series/Create Your Own Patient Chart Dividers

Size 1-1/4" x 1-1/2" (before folding)

Self-adhesive, laminated tabs help you organize information in patient files with color-coded edges for fast identification. Just choose which classifications you need and attach the pressure-sensitive tabs to the pre-printed position marks on our Chart Divider Sheets.

NOTE: Can also be used on any of our dividers or filebacks featured on page 34.

PACK (10 tabs/sheet 100 labels per pkg) (see label number)



Shown Actual Size

## Chart Divider Sheets

Size 8-1/2" x 11"

Organize your practice files and separate them into sections. The 110 lb. white or manila index stock has top and side position marks for chart tabs. Two and three-hole punched for top and side fastener or binder use.

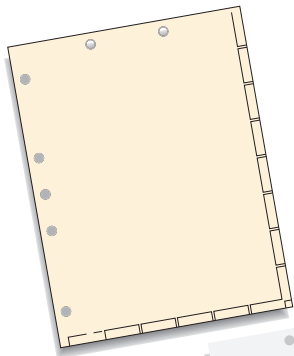

M400IN

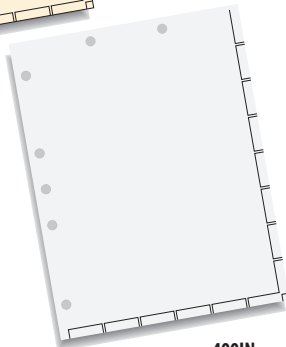

400IN

(100 sheets per pack)

<b>ADMISSIONS WORK-UP</b> Pack 401AW	<b>ALLERGY</b> Pack 444A	<b>BEHAVIOR NOTES</b> Pack 402BN	<b>CONFIDENTIAL</b> Pack 433C	<b>CONSENT FORMS</b> Pack 431CF
<b>CONSULTS</b> Pack 404C	<b>CORRESPONDENCE</b> Pack 405C	<b>CONSENT</b> Pack 462C	<b>DIAGNOSTIC</b> Pack 438D	<b>DISCHARGE SUMMARY</b> Pack 450DS
<b>EKG</b> Pack 403E	<b>EXAM RECORDS</b> Pack 430E	<b>ER/URGENT CARE</b> Pack 463ER	<b>FINAL DIAGNOSIS</b> Pack 406FD	<b>FLOW SHEETS</b> Pack 439FS
<b>GRAPHIC CHART</b> Pack 407GC	<b>HEALTH HISTORY</b> Pack 432H	<b>HIPAA</b> Pack 460HIP	<b>HISTORY &amp; PHYSICAL</b> Pack 408HP	<b>HOME HEALTH</b> Pack 452HH
<b>HOSPITAL</b> Pack 409H	<b>IMMUNIZATION</b> Pack 435I	<b>INSURANCE</b> Pack 410I	<b>LAB REPORTS</b> Pack 411LR	<b>LAB/X-RAY</b> Pack 412LX
<b>MAMMOGRAM</b> Pack 443MM	<b>MEDICAID</b> Pack 453MD	<b>MEDICARE</b> Pack 445ME	<b>MEDICATIONS</b> Pack 413ME	<b>MISC.</b> Pack 414MI
<b>NURSES NOTES</b> Pack 415NN	<b>O.B. RECORDS</b> Pack 446OB	<b>OPERATIVE REPORT</b> Pack 416OR	<b>OTHER NOTES</b> Pack 464ON	<b>OR RECORD-ANESTHESIA</b> Pack 417OA
<b>PRIVACY</b> Pack 461P	<b>PAP/MAMMO</b> Pack 447PM	<b>PAP SMEAR</b> Pack 456PS	<b>PATHOLOGY RESULTS</b> Pack 418PR	<b>PATIENT DATA</b> Pack 440PD
<b>PATIENT INFORMATION</b> Pack 428PI	<b>PHYSICAL</b> Pack 449PH	<b>PHYSICAL THERAPY</b> Pack 425PT	<b>PHYSICIANS ORDERS</b> Pack 419PO	<b>PRENATAL</b> Pack 451PN
<b>PRESCRIPTION</b> Pack 459PR	<b>PROBLEM LIST</b> Pack 454PL	<b>PROCEDURES</b> Pack 437P	<b>PROGRESS NOTES</b> Pack 420PN	<b>REFERRALS</b> Pack 436R
<b>RX</b> Pack 455RX	<b>SONOGRAM</b> Pack 457S	<b>SURGICAL</b> Pack 421S	<b>TELEPHONE</b> Pack 458T	<b>TREATMENT PLAN</b> Pack 429TP
<b>ULTRA SOUND</b> Pack 448US	<b>WORKMAN'S COMP.</b> Pack 426WC	<b>X-RAY</b> Pack 423X	<b>X-RAY-EKG</b> Pack 424XE	<b>Pack 427BK</b> <i>writable</i>
<b>Pack 434WBK</b> <i>writable</i>	<b>Pack 451RWO</b> <i>writable</i>	<b>Pack 452DBEWO</b> <i>writable</i>	<b>Pack 453DGNWO</b> <i>writable</i>	<b>Pack 454YWO</b> <i>writable</i>
<b>Pack 455GYWO</b> <i>writable</i>	<b>Pack 456BKWO</b> <i>writable</i>	<b>Pack 457ORWO</b> <i>writable</i>	<b>Pack 458LGNWO</b> <i>writable</i>	<b>Pack 459LBEWO</b> <i>writable</i>
<b>Pack 460TWO</b> <i>writable</i>				



# Index Tabs and Dividers

## 300 Series/Create Your Own Patient Chart Dividers

Size 1-1/2" x 1-1/2" (before folding)

Organize your patient files with our complete do-it-yourself indexing systems. Create up to thirty-eight individual divisions of the patient charts. Use as few or as many as necessary to organize your files efficiently. Self-adhesive tabs are brightly colored for instant recognition. They are Mylar laminated for extra long life.

NOTE: Can also be used on any of our dividers or filebacks featured on page 34.

PACK (6 tabs/sheet 102 labels per pkg)  
(see label number)

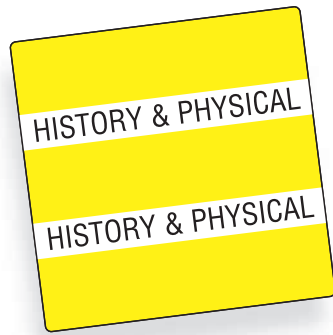

Shown Actual Size

## Chart Divider Sheets

Size 8-1/2" x 11"

Divider sheets are 110 lb. white or manila index stock. They are drilled on the top and side for fastener or binder use. Guide lines are preprinted for accurate label application.

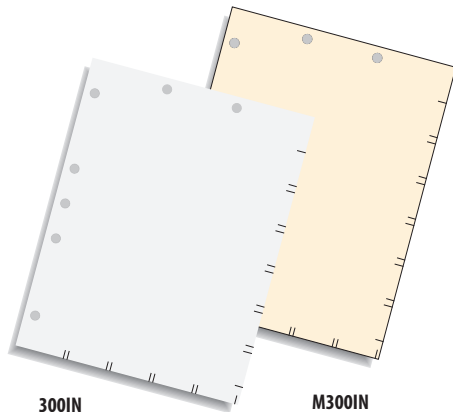

300IN

M300IN

(100 sheets per pack)

Pack 301A	Pack 317A	Pack 319A	Pack 302B	Pack 339C
Pack 340CF	Pack 341C	Pack 303C	Pack 325D	Pack 327DR
Pack 342D	Pack 343DS	Pack 304D	Pack 305E	Pack 344ER
Pack 324F	Pack 345FS	Pack 346HH	Pack 306HI	Pack 338HO
Pack 307HO	Pack 347I	Pack 308I	Pack 309L	Pack 348LX
Pack 349LW	Pack 326M	Pack 350M	Pack 351M	Pack 323MC
Pack 330M	Pack 310ME	Pack 311MI	Pack 329N	Pack 352OB
Pack 353OR	Pack 322OP	Pack 354OR	Pack 355PM	Pack 320P
Pack 356PR	Pack 312PA	Pack 357PI	Pack 358P	Pack 318PT
Pack 365P	Pack 368P	Pack 370P	Pack 359PL	Pack 328P
Pack 313PR	Pack 314R	Pack 360RX	Pack 336SP	Pack 316S
Pack 369S	Pack 361T	Pack 362TP	Pack 363US	Pack 321W
Pack 315X	Pack 364XE	Pack 331BE	Pack 332GN	Pack 334PK
Pack 333Y				



# Self-Adhesive Dividers and Filebacks

## Self-Adhesive Dividers and Filebacks Help Organize

Divide the contents of your folders to better organize documents. Easy to install. Use more than one style together in a folder. All dividers are made from 11 pt manila stock and have a 7/8" flap with self-adhesive tape. Die-cuts on flaps allow positioning around fasteners.

**Folders sold separately**

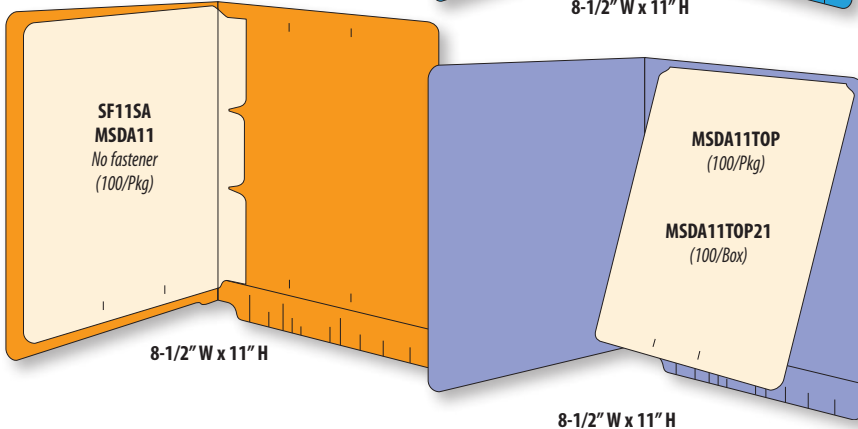
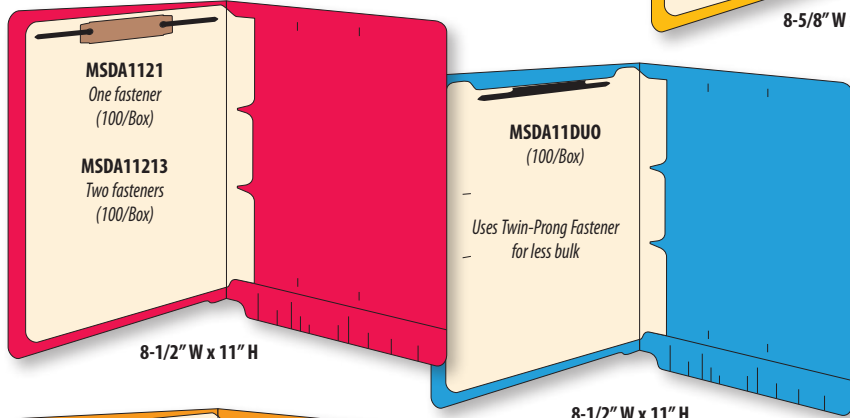
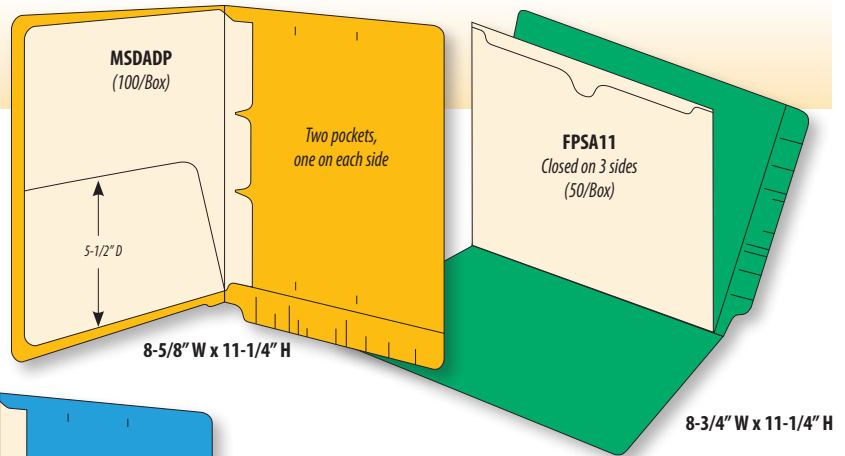

All sizes do not include 7/8" flap

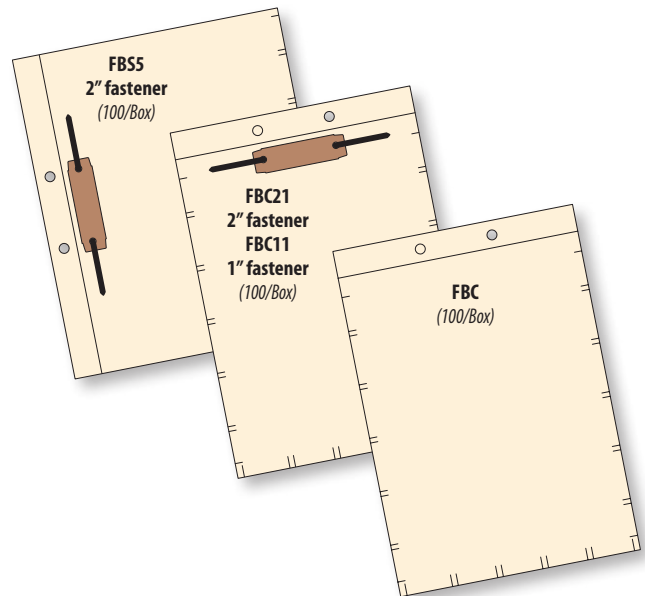
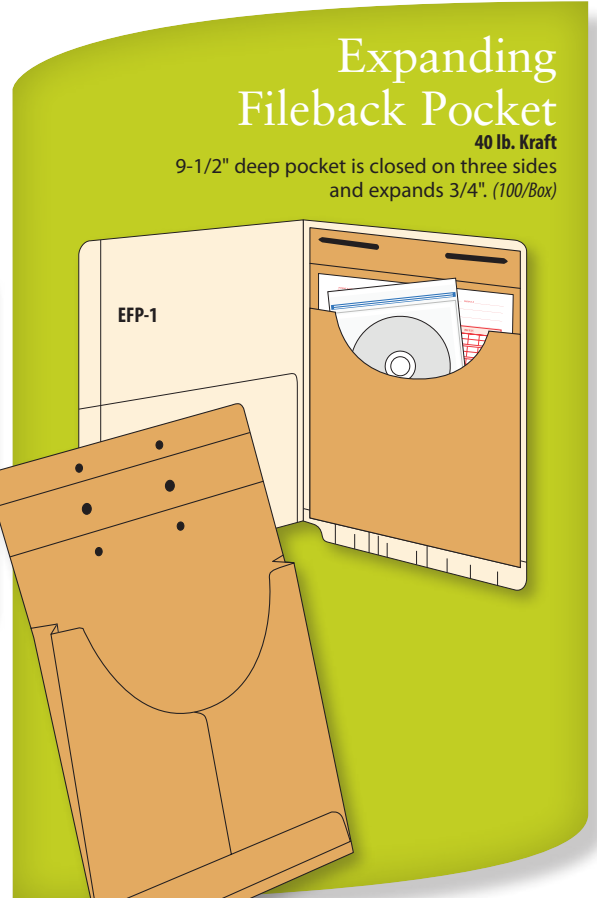

## Fileback Dividers

- Add or remove sheets without tearing apart files
- Choose end or side fastener dividers

Now get immediate access to each section without removing top sections from the chart. Just fold on score line to form flap and slip divider over existing fastener in folder. The next divider is attached to the fastener on the first divider, and so on. Sturdy 11 pt manila stock.

# LABELS



## Color Code Filing

Applying labels to the file folder tab to color code your filing systems adds a number of benefits and efficiencies to your filing system. Two of the more prominent benefits are referencing and locating file folders within the system and, perhaps the most cost saving benefit, is locating misfiles within a filing system. Using color coding in your filing system can speed up referencing and spotting costly misfiles by as much as 70 percent

### The four most commonly used methods of color coding are as follows:

**Alphabetical**-The use of alpha labels to designate a file by patient, client or customer name. By using the first few characters of a name, there is little to no need for a cross reference system to access active files. The amount of alpha letters needed to color code a single file is determined by the size of the overall filing system, frequency of common names, etc. . .

**Straight Numeric**-The use of numeric labels to designate a file by customer number, date, social security number, etc. . . Use of numeric labels usually requires some level of cross reference and is very simple in nature. The most recent file (new customer, patient, etc. . . ) is usually found at the end of a straight numeric filing system.

**Alpha/Numeric**-The use of a combination of alpha and numeric labels to create a filing system. The use of both alpha and numeric labels are used to create a specific file for customer files, court files, service records, property management files, etc. . .

**Terminal Digit**-The use of numeric labels for large volume filing systems. This unique systems breaks large filing systems up in groups of 100 or 1000 files, depending on the overall size of the filing system. This type of system places the initial emphasis on the ending digits of the file number to speed referencing, thus the name "Terminal Digit". You are basically creating smaller systems, or groups, within the entire filing system.

Other labels such as Year, Month, Solid (designator) labels can be used to further departmentalize or detail the information located on the tabs of files within your filing system.

# Alphabetic Color Coded Labels

## 3900 Series

1" H x 1-1/2" W (Polylaminated)



Pack 3900A  
Ringbook 3930A  
Roll 3960A



Pack 3901B  
Ringbook 3931B  
Roll 3961B



Pack 3902C  
Ringbook 3932C  
Roll 3962C



Pack 3903D  
Ringbook 3933D  
Roll 3963D



Pack 3904E  
Ringbook 3934E  
Roll 3964E



Pack 3905F  
Ringbook 3935F  
Roll 3965F



Pack 3906G  
Ringbook 3936G  
Roll 3966G



Pack 3907H  
Ringbook 3937H  
Roll 3967H



Pack 3908I  
Ringbook 3938I  
Roll 3968I



Pack 3909J  
Ringbook 3939J  
Roll 3969J



Pack 3910K  
Ringbook 3940K  
Roll 3970K



Pack 3911L  
Ringbook 3941L  
Roll 3971L



Pack 3912M  
Ringbook 3942M  
Roll 3972M



Pack 3913N  
Ringbook 3943N  
Roll 3973N



Pack 3914O  
Ringbook 3944O  
Roll 3974O



Pack 3915P  
Ringbook 3945P  
Roll 3975P

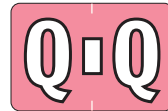

Pack 3916Q  
Ringbook 3946Q  
Roll 3976Q



Pack 3917R  
Ringbook 3947R  
Roll 3977R



Pack 3918S  
Ringbook 3948S  
Roll 3978S



Pack 3919T  
Ringbook 3949T  
Roll 3979T



Pack 3920U  
Ringbook 3950U  
Roll 3980U



Pack 3921V  
Ringbook 3951V  
Roll 3981V



Pack 3922W  
Ringbook 3952W  
Roll 3982W



Pack 3923X  
Ringbook 3953X  
Roll 3983X



Pack 3924Y  
Ringbook 3954Y  
Roll 3984Y



Pack 3925Z  
Ringbook 3955Z  
Roll 3985Z



Pack 3926Mc  
Ringbook 3956Mc  
Roll 3986Mc



Pack 3926St  
Ringbook 3956St  
Roll 3986St

### RINGBOOK (24 labels/sheet)

Binder only for starter kit-Item # MBINDER

Index set for starter kit-Item # MINDEX

**Individual Letters**  
(see label number) 240 labels

**Complete Set 3959SET**

28 packs/6,720 labels

**Starter Kit 3957SK**

Binder, Indexes, 3,144 assorted labels

**Refill Kit 3958RK**

3,144 assorted labels

### PACK (9 labels/sheet)

Kit box only for starter kit-Item # BBOX

Index set for starter kit-Item # BINDEX

**Individual Letters**  
(see label number) 225 labels

**Complete Set 3929SET**

28 packs/6,300 labels

**Starter Kit 3927SK**

File box, Indexes, 2,016 assorted labels

**Refill Kit 3928RK**

2,016 assorted labels

### ROLL (500 labels/roll)

**Individual Letters**

(see label number) 500 labels

**Complete Set 3989SET**

28 rolls, display unit, 14,000 labels

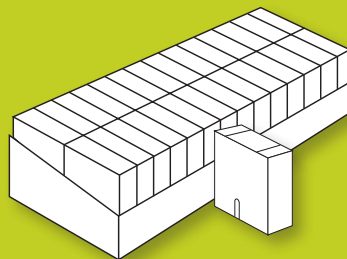
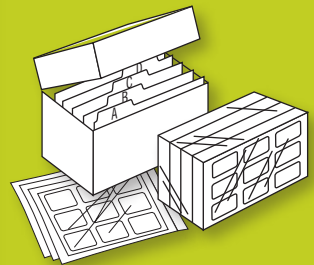
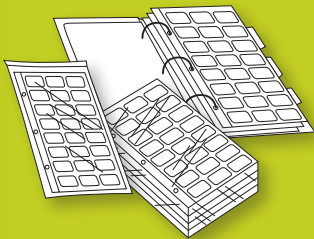

# Alphabetic Color Coded Labels

## Controlled Alphabetic Placement C.A.P. System 2500/2600/1300 Series 11-1/16" H x 1-1/4" W (Tyvek) "A Truly Logical Filing System"

### 2500 Series

C.A.P. SECOND LETTER/LAST NAME

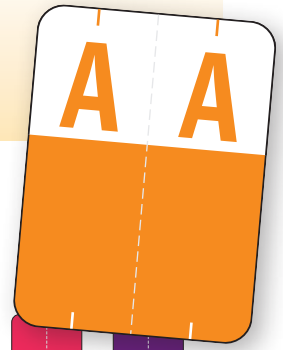
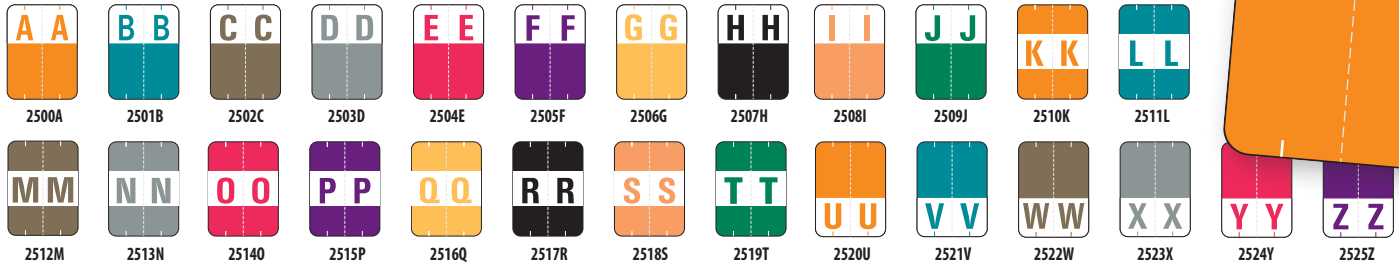

#### Controlled Alphabetic Placement Series 2500.

##### Replacement Package

(see label number) *Contains 100 like labels per poly package.*

##### Starter Kit 2527SK

Kit box only for starter kits (2500, 2600, 2600/1300 Series)-Item # SDBOX1C

*Contains 2,035 assorted Tyvek Labels (1,035 CAP 2500 and 1,000 CAP 2600 labels.) Packaged in a box with index.*

##### Refill Kit 2528RK

*Contains 2,035 assorted labels only.*

*Does not include box or index.*

##### Primary Alpha Labels:

##### Complete Set 2529SET

*26 packages, A thru Z, 2,600 labels*

### 2600 Series

C.A.P. FIRST LETTER/FIRST NAME

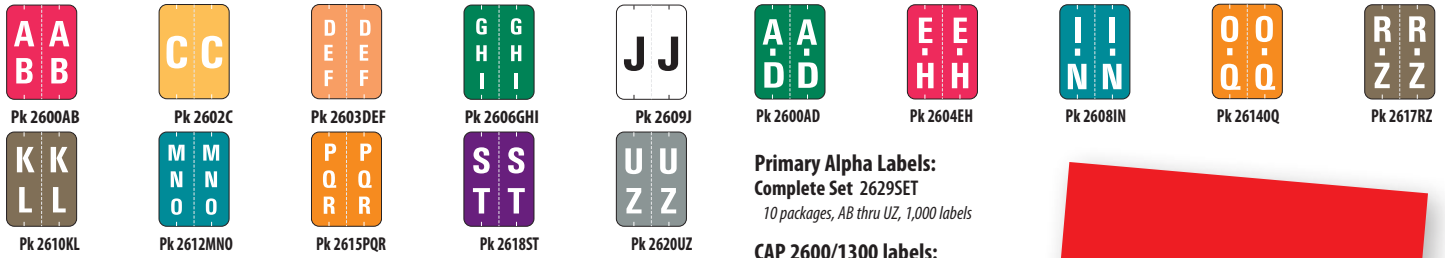

### 2600/1300 Series

C.A.P. SECOND LETTER/LAST NAME

##### Primary Alpha Labels:

##### Complete Set 2629SET

*10 packages, AB thru UZ, 1,000 labels*

##### CAP 2600/1300 labels:

##### Complete Set 2639SET

*5 packages, AD thru RZ, 500 labels*



### 10500 Series

Ames® L178 Compatible

1-7/8" H x 1-7/8" W (Semi-Gloss)



**ROLL (500 labels/roll)**  
Individual Letters  
(see label number) 500 labels  
**Complete Set 10589SET**  
*26 rolls, 13,000 labels*





# Alphabetic Color Coded Labels

## 2100 Series

Bibbero® 31-8100/33-8100 Compatible  
1-1/4" H x 1-1/4" W (Polylaminated)



## 3100/3100-200 Series

Col'R'Tab® 12000/12030 Compatible,  
1" H x 1-1/2" W (Polylaminated)

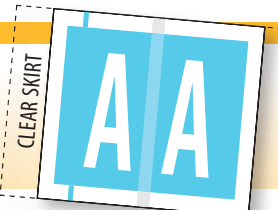

Rngbk 2130A Roll 2160A	Rngbk 2131B Roll 2161B	Rngbk 2132C Roll 2162C	Rngbk 2133D Roll 2163D	Rngbk 2134E Roll 2164E
Rngbk 2135F Roll 2165F	Rngbk 2136G Roll 2166G	Rngbk 2137H Roll 2167H	Rngbk 2138I Roll 2168I	Rngbk 2139J Roll 2169J
Rngbk 2140K Roll 2170K	Rngbk 2141L Roll 2171L	Rngbk 2142M Roll 2172M	Rngbk 2143N Roll 2173N	Rngbk 2144O Roll 2174O
Rngbk 2145P Roll 2175P	Rngbk 2146Q Roll 2176Q	Rngbk 2147R Roll 2177R	Rngbk 2148S Roll 2178S	Rngbk 2149T Roll 2179T
Rngbk 2150U Roll 2180U	Rngbk 2151V Roll 2181V	Rngbk 2152WX Roll 2182WX	Rngbk 2153X Roll 2183X	Rngbk 2154YZ Roll 2184YZ
		<b>Alternate Characters</b>		
Rngbk 2155Z Roll 2185Z	Rngbk 2156Mc Roll 2186Mc			
		Rngbk 2152-200W Roll 2182-200W	Rngbk 2154-200Y Roll 2184-200Y	

Pack 3100A Roll 3160A	Pack 3101B Roll 3161B	Pack 3102C Roll 3162C	Pack 3103D Roll 3163D	Pack 3104E Roll 3164E	Pack 3105F Roll 3165F
Pack 3106G Roll 3166G	Pack 3107H Roll 3167H	Pack 3108I Roll 3168I	Pack 3109J Roll 3169J	Pack 3110K Roll 3170K	Pack 3111L Roll 3171L
Pack 3112M Roll 3172M	Pack 3113N Roll 3173N	Pack 3114O Roll 3174O	Pack 3115P Roll 3175P	Pack 3116Q Roll 3176Q	Pack 3117R Roll 3177R
Pack 3118S Roll 3178S	Pack 3119T Roll 3179T	Pack 3120U Roll 3180U	Pack 3121V Roll 3181V	Pack 3122W Roll 3182W	Pack 3123X Roll 3183X
Pack 3124Y Roll 3184Y	Pack 3125Z Roll 3185Z	Pack 3126Mc Roll 3186Mc			

### -200 Series Alternates

Pack 3113-200N Roll 3173-200N	Pack 3114-200O Roll 3174-200O	Pack 3115-200P Roll 3175-200P
Pack 3116-200Q Roll 3176-200Q	Pack 3117-200R Roll 3177-200R	Pack 3118-200S Roll 3178-200S
Pack 3119-200T Roll 3179-200T	Pack 3120-200U Roll 3180-200U	Pack 3121-200V Roll 3181-200V
Pack 3122-200W Roll 3182-200W	Pack 3123-200X Roll 3183-200X	Pack 3124-200Y Roll 3184-200Y
	Pack 3125-200Z Roll 3185-200Z	

-200 Alternates provide solid color blocks for easier identification

**RINGBOOK** (24 labels/sheet)  
Binder only for starter kit-Item # MBINDER  
Index set for starter kit-Item # MINDEX  
**Individual Letters**  
(see label number) 240 labels  
**Complete Sets**  
2159SET (25 packs/6,000 labels)  
2159-200SET (27 packs/6,480 labels)

**Starter Kits**  
(Binder, indexes and labels)  
2157SK (4 sheets each/2,400 labels)  
2157-200SK (4 sheets each, 2-W, X, Y, Z  
2,400 labels)  
**Refill Kits** (Same as Starter without  
binder or indexes)  
2158RK (100 sheets/2,400 labels)  
2158-200RK (100 sheets/2,400 labels)

**ROLL** (250 labels/roll)  
**Individual Letters**  
(see label number) 250 labels  
**Complete Sets**  
2189SET  
(25 rolls with WX, YZ 6,250 labels)  
2189-200SET  
(27 rolls with W, X, Y, Z 6,750 labels)

## 3700 Series

Col'R'Tab® 11950 Compatible,  
1/2" H x 1-1/2" W  
(Polylaminated 100# Tag)



Pack 3700A Roll 3760A	Pack 3701B Roll 3761B	Pack 3702C Roll 3762C	Pack 3703D Roll 3763D	Pack 3704E Roll 3764E	Pack 3705F Roll 3765F
Pack 3706G Roll 3766G	Pack 3707H Roll 3767H	Pack 3708I Roll 3768I	Pack 3709J Roll 3769J	Pack 3710K Roll 3770K	Pack 3711L Roll 3771L
Pack 3712M Roll 3772M	Pack 3713N Roll 3773N	Pack 3714O Roll 3774O	Pack 3715P Roll 3775P	Pack 3716Q Roll 3776Q	Pack 3717R Roll 3777R
Pack 3718S Roll 3778S	Pack 3719T Roll 3779T	Pack 3720U Roll 3780U	Pack 3721V Roll 3781V	Pack 3722W Roll 3782W	Pack 3723X Roll 3783X
Pack 3724Y Roll 3784Y	Pack 3725Z Roll 3785Z				

**PACK** (10 labels/sheet)  
Kit box only for starter kit-Item # SDBOX20  
**Individual Letters** (see label number) 100 labels  
**Complete Set** 3729SET 26 packs/2,600 labels  
**Starter Kit** 3727SK Box, Indexes, 3,200 assorted labels  
**Refill Kit** 3728RK 3,200 assorted labels  
**ROLL** (500 labels/roll)  
**Individual Letters** (see label number) 500 labels  
**Complete Set** 3789SET 26 rolls, 13,000 labels

# Alphabetic Color Coded Labels

## 8600 Series

Colwell Jewel Tone Compatible  
1" H x 1-1/2" W (Polylaminated)



Pack 8600A  
Ringbook 8630A  
Roll 8660A  
Map Pack 86M00A



Pack 8601B  
Ringbook 8631B  
Roll 8661B  
Map Pack 86M01B



Pack 8602C  
Ringbook 8632C  
Roll 8662C  
Map Pack 86M02C



Pack 8603D  
Ringbook 8633D  
Roll 8663D  
Map Pack 86M03D



Pack 8604E  
Ringbook 8634E  
Roll 8664E  
Map Pack 86M04E



Pack 8605F  
Ringbook 8635F  
Roll 8665F  
Map Pack 86M05F



Pack 8606G  
Ringbook 8636G  
Roll 8666G  
Map Pack 86M06G



Pack 8607H  
Ringbook 8637H  
Roll 8667H  
Map Pack 86M07H



Pack 8608I  
Ringbook 8638I  
Roll 8668I  
Map Pack 86M08I



Pack 8609J  
Ringbook 8639J  
Roll 8669J  
Map Pack 86M09J



Pack 8610K  
Ringbook 8640K  
Roll 8670K  
Map Pack 86M10K



Pack 8611L  
Ringbook 8641L  
Roll 8671L  
Map Pack 86M11L



Pack 8612M  
Ringbook 8642M  
Roll 8672M  
Map Pack 86M12M



Pack 8613N  
Ringbook 8643N  
Roll 8673N  
Map Pack 86M13N



Pack 8614O  
Ringbook 8644O  
Roll 8674O  
Map Pack 86M14O



Pack 8615P  
Ringbook 8645P  
Roll 8675P  
Map Pack 86M15P

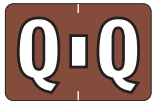

Pack 8616Q  
Ringbook 8646Q  
Roll 8676Q  
Map Pack 86M16Q



Pack 8617R  
Ringbook 8647R  
Roll 8677R  
Map Pack 86M17R



Pack 8618S  
Ringbook 8648S  
Roll 8678S  
Map Pack 86M18S



Pack 8619T  
Ringbook 8649T  
Roll 8679T  
Map Pack 86M19T



Pack 8620U  
Ringbook 8650U  
Roll 8680U  
Map Pack 86M20U



Pack 8621V  
Ringbook 8651V  
Roll 8681V  
Map Pack 86M21V



Pack 8622W  
Ringbook 8652W  
Roll 8682W  
Map Pack 86M22W



Pack 8623X  
Ringbook 8653X  
Roll 8683X  
Map Pack 86M23X



Pack 8624Y  
Ringbook 8654Y  
Roll 8684Y  
Map Pack 86M24Y



Pack 8625Z  
Ringbook 8655Z  
Roll 8685Z  
Map Pack 86M25Z



Pack 8626Mc  
Ringbook 8656Mc  
Roll 8686Mc  
Map Pack 86M26Mc

### MAP-PACK (9 labels/sheet)

**Individual Letters**  
(see label number) 225 labels

### Starter Kit 86M27SK

File box, Indexes, 2,016 assorted labels

### PACK (9 labels/sheet)

Kit box only for starter kit-Item # BBOX  
Index set for starter kit-Item # BINDEX

### Individual Letters

(see label number) 225 labels

### Starter Kit 1327SK

File box, Indexes, 2,016 assorted labels

### RINGBOOK (24 labels/sheet)

Binder only for starter kit-Item # MBINDER  
Index set for starter kit-Item # MINDEX

### Individual Letters

(see label number) 240 labels

### Starter Kit 8657SK

Binder, Indexes, 3,144 assorted labels

### ROLL (500 labels/roll)

### Individual Letters

(see label number) 500 labels

### Complete Set 8689SET

28 rolls, display unit, 14,000 labels

## 2300 Series

Control-O-Fax® 96-00-000  
Compatible  
15/16" H x 1-5/8" W (Vinyl)

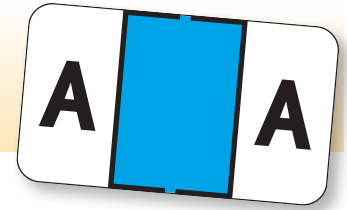

Rngbk 2330A



Rngbk 2331B



Rngbk 2332C



Rngbk 2333D



Rngbk 2334E



Rngbk 2335F



Rngbk 2336G



Rngbk 2337H

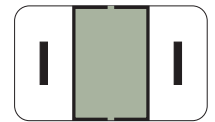

Rngbk 2338I



Rngbk 2339J



Rngbk 2340K



Rngbk 2341L



Rngbk 2342M



Rngbk 2343N



Rngbk 2344O



Rngbk 2345P



Rngbk 2346Q



Rngbk 2347R



Rngbk 2348S



Rngbk 2349T



Rngbk 2350U



Rngbk 2351V



Rngbk 2352W



Rngbk 2353X



Rngbk 2354Y



Rngbk 2355Z



Rngbk 2356Mc

### RINGBOOK (24 labels/sheet)

Binder only for starter kit-Item # MBINDER  
Index set for starter kit-Item # MINDEX

### Individual Letters

(see label number) 240 labels

### Complete Set 2359SET,

27 packs/6,480 labels

### Starter Kit 2357SK,

Binder, Indexes,  
3,072 assorted labels

### Refill Kit 2358RK,

3,072 assorted labels

# Alphabetic Color Coded Labels

## 10400 Series

Datafile® DF751/DF8701 Compatible  
15/16" H x 1-1/4" W (Polylaminated)



**Z-Z**  
Pack 10425Z  
Roll 10485Z

**PACK (16 labels/sheet)**  
Kit box only for starter kit-Item # BBOX  
Index set for starter kit-Item # AINDEX  
**Individual Letters**  
(see label number) 240 labels  
**Complete Set 10429SET**  
26 packs/6,240 labels  
**Starter Kit 10427SK**  
File box, indexes, 3,840 assorted labels

**Refill Kit 10428RK**  
3,840 assorted labels  
**ROLL (500 labels/roll)**  
**Individual Letters**  
(see label number) 500 labels  
**Complete Set 10489SET**  
26 rolls, display unit, 13,000 labels

## 3400 Series

File Doctor® L9997SS Compatible  
1" H x 1-1/4" W (Vinyl)

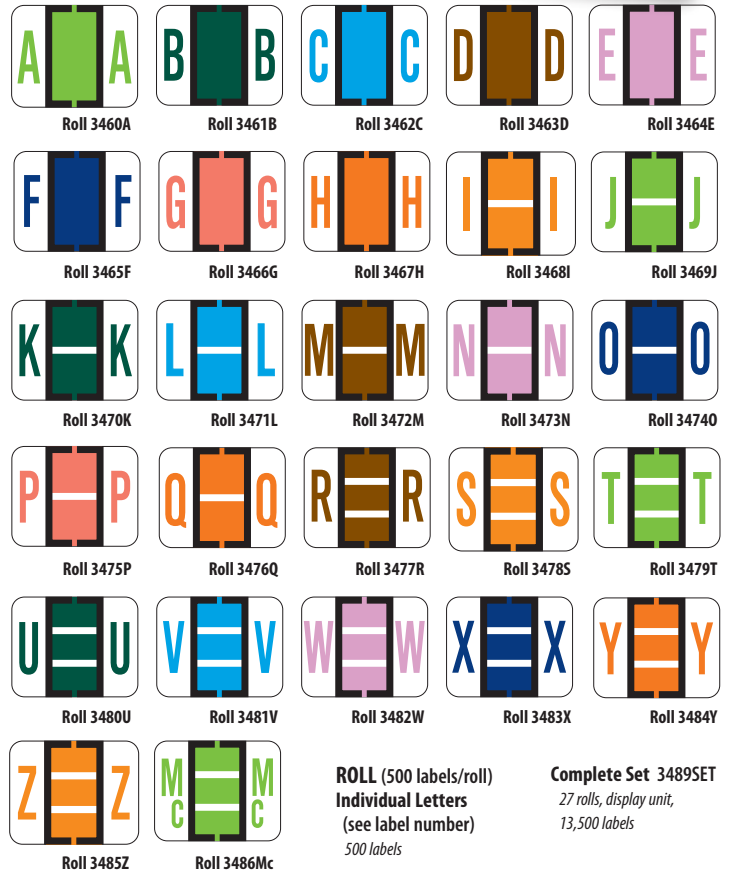
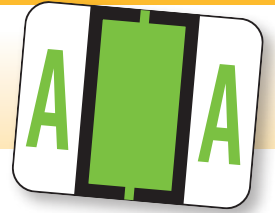

**ROLL (500 labels/roll)**  
**Individual Letters**  
(see label number)  
500 labels  
**Complete Set 3489SET**  
27 rolls, display unit,  
13,500 labels

## 3000 Series

GBS® (VRE) 8848/8850 Compatible,  
15/16" H x 1-1/4" W (Polylaminated)



**RINGBOOK (10 labels/sheet)**  
Binder only for starter kit-Item # SBINDER  
Index set for starter kit-Item # SINDEK  
**Individual Letters**  
(see label number) 200 labels  
**Complete Set 3059SET**  
27 packs/5,400 labels  
**Starter Kit 3057SK**  
Binder, Indexes, 1,010 assorted labels









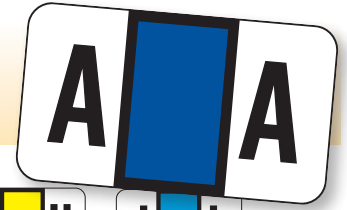

















**Refill Kit 3058RK**  
1,010 assorted labels  
**ROLL (500 labels/roll)**  
**Individual Letters**  
(see label number) 500 labels  
**Complete Set 3089SET**  
27 rolls, 13,500 labels

# Alphabetic Color Coded Labels

## 1400 Series









JETER® 2500 Compatible  
15/16" H x 1-5/8" W (Polylaminated)



 Pack 1400A Rngbk 1430A Roll 1460A	 Pack 1401B Rngbk 1431B Roll 1461B	 Pack 1402C Rngbk 1432C Roll 1462C	 Pack 1403D Rngbk 1433D Roll 1463D	 Pack 1404E Rngbk 1434E Roll 1464E	 Pack 1405F Rngbk 1435F Roll 1465F	 Pack 1406G Rngbk 1436G Roll 1466G	 Pack 1407H Rngbk 1437H Roll 1467H	 Pack 1408I Rngbk 1438I Roll 1468I
 Pack 1409J Rngbk 1439J Roll 1469J	 Pack 1410K Rngbk 1440K Roll 1470K	 Pack 1411L Rngbk 1441L Roll 1471L	 Pack 1412M Rngbk 1442M Roll 1472M	 Pack 1413N Rngbk 1443N Roll 1473N	 Pack 1414O Rngbk 1444O Roll 1474O	 Pack 1415P Rngbk 1445P Roll 1475P	 Pack 1416Q Rngbk 1446Q Roll 1476Q	 Pack 1417R Rngbk 1447R Roll 1477R
 Pack 1418S Rngbk 1448S Roll 1478S	 Pack 1419T Rngbk 1449T Roll 1479T	 Pack 1420U Rngbk 1450U Roll 1480U	 Pack 1421V Rngbk 1451V Roll 1481V	 Pack 1422W Rngbk 1452W Roll 1482W	 Pack 1423X Rngbk 1453X Roll 1483X	 Pack 1424Y Rngbk 1454Y Roll 1484Y	 Pack 1425Z Rngbk 1455Z Roll 1485Z	 Pack 1426Mc Rngbk 1456Mc Roll 1486Mc

## 1400-200 series

Alternates

 Rngbk 1432-200C Roll 1462-200C	 Rngbk 1436-200G Roll 1466-200G	 Rngbk 1438-200I Roll 1468-200I	 Rngbk 1441-200L Roll 1471-200L
 Rngbk 1445-200P Roll 1475-200P	 Rngbk 1449-200T Roll 1479-200T	 Rngbk 1451-200V Roll 1481-200V	 Rngbk 1454-200Y Roll 1484-200Y

### PACK (9 labels/sheet)

Kit box only for starter kit-Item # BBOX  
Index set for starter kit-Item # BINDEX

**Individual Letters**  
(see label number) 225 labels

**Complete Set 1429SET**  
27 packs/6,075 labels

**Starter Kit 1427SK**  
File box, Indexes, 2,898 assorted labels

**Refill Kit 1428RK**  
2,898 assorted labels

### RINGBOOK (24 labels/sheet)

Binder only for starter kit-Item # MBINDER  
Index set for starter kit-Item # MINDEX

**Individual Letters**  
(see label number) 240 labels

**Complete Set 1459SET, 1459-200SET**  
27 packs/6,480 labels

**Starter Kit 1457SK, 1457-200SK**  
Binder, Indexes, 3,471 assorted labels

**Refill Kit 1458RK, 1458-200RK**  
3,120 assorted labels (alpha only)

### ROLL (500 labels/roll)



























**Individual Letters**  
(see label number) 500 labels

**Complete Set 1489SET, 1489-200SET**  
27 rolls, display unit, 13,500 labels

## 1300 Series

JETER® 7200, 7100 & 5800 Compatible, 15/16" H x 1-5/8" W (Polylaminated)



 MAP-Pack 13M00A Pack 1300A Ringbook 1330A Roll 1360A	 MAP-Pack 13M01B Pack 1301B Ringbook 1331B Roll 1361B	 MAP-Pack 13M02C Pack 1302C Ringbook 1332C Roll 1362C	 MAP-Pack 13M03D Pack 1303D Ringbook 1333D Roll 1363D	 MAP-Pack 13M04E Pack 1304E Ringbook 1334E Roll 1364E	 MAP-Pack 13M05F Pack 1305F Ringbook 1335F Roll 1365F	 MAP-Pack 13M06G Pack 1306G Ringbook 1336G Roll 1366G	 MAP-Pack 13M07H Pack 1307H Ringbook 1337H Roll 1367H	 MAP-Pack 13M08I Pack 1308I Ringbook 1338I Roll 1368I
 MAP-Pack 13M09J Pack 1309J Ringbook 1339J Roll 1369J	 MAP-Pack 13M10K Pack 1310K Ringbook 1340K Roll 1370K	 MAP-Pack 13M11L Pack 1311L Ringbook 1341L Roll 1371L	 MAP-Pack 13M12M Pack 1312M Ringbook 1342M Roll 1372M	 MAP-Pack 13M13N Pack 1313N Ringbook 1343N Roll 1373N	 MAP-Pack 13M14O Pack 1314O Ringbook 1344O Roll 1374O	 MAP-Pack 13M15P Pack 1315P Ringbook 1345P Roll 1375P	 MAP-Pack 13M16Q Pack 1316Q Ringbook 1346Q Roll 1376Q	 MAP-Pack 13M17R Pack 1317R Ringbook 1347R Roll 1377R
 MAP-Pack 13M18S Pack 1318S Ringbook 1348S Roll 1378S	 MAP-Pack 13M19T Pack 1319T Ringbook 1349T Roll 1379T	 MAP-Pack 13M20U Pack 1320U Ringbook 1350U Roll 1380U	 MAP-Pack 13M21V Pack 1321V Ringbook 1351V Roll 1381V	 MAP-Pack 13M22W Pack 1322W Ringbook 1352W Roll 1382W	 MAP-Pack 13M23X Pack 1323X Ringbook 1353X Roll 1383X	 MAP-Pack 13M24Y Pack 1324Y Ringbook 1354Y Roll 1384Y	 MAP-Pack 13M25Z Pack 1325Z Ringbook 1355Z Roll 1385Z	 MAP-Pack 13M26Mc Pack 1326Mc Ringbook 1356Mc Roll 1386Mc

**MAP-PACK (9 labels/sheet)**  
Kit box only for starter kit-Item # BBOX  
Index set for starter kit-Item # BINDEX

**Individual Letters**  
(see label number) 126 labels

**Complete Set 13M29SET**  
27 packs/3,402 labels

**Starter Kit 13M27SK**

File box, Indexes, 2,025 assorted labels

**Refill Kit 13M28RK**  
2,025 assorted labels

**PACK (9 labels/sheet)**  
Kit box only for starter kit-Item # BBOX  
Index set for starter kit-Item # BINDEX

**Individual Letters**  
(see label number) 225 labels

**Complete Set 1329SET**

27 packs/6,075 labels  
**Starter Kit 1327SK**

File box, Indexes, 2,898 assorted labels

**Refill Kit 1328RK**  
2,898 assorted labels

**RINGBOOK (24 labels/sheet)**

Binder only for starter kit-Item # MBINDER  
Index set only for starter kit-Item # MINDEX

**Individual Letters**  
(see label number) 240 labels

**Complete Set 1359SET**  
27 packs/6,480 labels

**Starter Kit 1357SK**

Binder, Indexes, 3,471 assorted labels

**Refill Kit 1358RK**  
3,120 assorted labels (ALPHA only)

**ROLL (500 labels/roll)**  
**Individual Letters**  
(see label number) 500 labels

**Complete Set 1389SET**  
27 rolls, display unit, 13,500 labels

# Alphabetic Color Coded Labels

## 1800 Series JETER® 5100 Compatible, 15/16" H x 1-5/8" W (Poly laminated)



Pack 1800A Roll 1860A	Pack 1801B Roll 1861B	Pack 1802C Roll 1862C	Pack 1803D Roll 1863D	Pack 1804E Roll 1864E
Pack 1805FB Roll 1865FB	Pack 1806G Roll 1866G	Pack 1807H Roll 1867H	Pack 1808I Roll 1868I	Pack 1809J Roll 1869J
Pack 1810K Roll 1870K	Pack 1811L Roll 1871L	Pack 1812M Roll 1872M	Pack 1813N Roll 1873N	Pack 1814OB Roll 1874OB
Pack 1815P Roll 1875P	Pack 1816Q Roll 1876Q	Pack 1817R Roll 1877R	Pack 1818S Roll 1878S	Pack 1819T Roll 1879T
Pack 1820U Roll 1880U	Pack 1821V Roll 1881V	Pack 1822W Roll 1882W	Pack 1823X Roll 1883X	Pack 1824Y Roll 1884Y
		<b>Alternate Characters</b>		
Pack 1825Z Roll 1885Z	Pack 1826Mc Roll 1886Mc			Pack 1805FY Roll 1865FY
				Pack 1814OY Roll 1874OY

## 1600 Series JETER® 2900 Compatible, 3/4" H x 1-1/2" W (Poly laminated)



Rngbk 1630A Roll 1660A	Rngbk 1631B Roll 1661B	Rngbk 1632C Roll 1662C	Rngbk 1633D Roll 1663D	Rngbk 1634E Roll 1664E
Rngbk 1635F Roll 1665F	Rngbk 1636G Roll 1666G	Rngbk 1637H Roll 1667H	Rngbk 1638I Roll 1668I	Rngbk 1639J Roll 1669J
Rngbk 1640K Roll 1670K	Rngbk 1641L Roll 1671L	Rngbk 1642M Roll 1672M	Rngbk 1643N Roll 1673N	Rngbk 1644O Roll 1674O
Rngbk 1645P Roll 1675P	Rngbk 1646Q Roll 1676Q	Rngbk 1647R Roll 1677R	Rngbk 1648S Roll 1678S	Rngbk 1649T Roll 1679T
Rngbk 1650U Roll 1680U	Rngbk 1651V Roll 1681V	Rngbk 1652W Roll 1682W	Rngbk 1653X Roll 1683X	Rngbk 1654Y Roll 1684Y
Rngbk 1655Z Roll 1685Z	Rngbk 1656Mc Roll 1686Mc			

**PACK** (9 labels/sheet)  
Kit box only for starter kit-Item # BBOX  
Index set for starter kit-Item # BINDEX

**Individual Letters**  
(see label number) 225 labels

**Complete Sets** 27 pks, 6,075 labels  
1829SETB ● (Blue)  
1829SETY ● (Yellow)

**Starter Kits** Box, Indxs., 2,898 asst. labels  
1827SKB ● (Blue)

1827SKY ● (Yellow)  
**Refill Kits** 2,898 assorted labels  
1828RKB ● (Blue)  
1828RKY ● (Yellow)

**ROLL** (500 labels/roll)  
**Individual Letters**  
(see label number) 500 labels

**Complete Sets** 27 rolls, display unit, 13,500 labels  
1889SETB ● (Blue)  
1889SETY ● (Yellow)

**RINGBOOK** (27 labels/sheet)  
Binder only for starter kit-Item # MBINDER  
Index set only for starter kit-Item # MINDEX

**Individual Letters**  
(see label number) 270 labels

**Complete Set** 1689SET  
27 packs/7,290 labels

**Starter Kit** 1657SK  
Binder, Indexes, 3,861 assorted labels

**Refill Kit** 1658RK  
3,510 assorted labels

**ROLL** (500 labels/roll)  
**Individual Letters**  
(see label number) 500 labels

**Complete Set** 1689SET  
27 rolls, display unit, 13,500 labels

## 2200 Series JETER® Double "J" Compatible 15/16" H x 1-5/8" W (Poly laminated)



Rngbk 2230A Roll 2260A	Rngbk 2231B Roll 2261B	Rngbk 2232C Roll 2262C	Rngbk 2233D Roll 2263D	Rngbk 2234E Roll 2264E	Rngbk 2235F Roll 2265F
Rngbk 2236G Roll 2266G	Rngbk 2237H Roll 2267H	Rngbk 2238I Roll 2268I	Rngbk 2239J Roll 2269J	Rngbk 2240K Roll 2270K	Rngbk 2241L Roll 2271L
Rngbk 2242M Roll 2272M	Rngbk 2243N Roll 2273N	Rngbk 2244O Roll 2274O	Rngbk 2245P Roll 2275P	Rngbk 2246Q Roll 2276Q	Rngbk 2247R Roll 2277R
Rngbk 2248S Roll 2278S	Rngbk 2249T Roll 2279T	Rngbk 2250U Roll 2280U	Rngbk 2251V Roll 2281V	Rngbk 2252W Roll 2282W	Rngbk 2253X Roll 2283X
Rngbk 2254Y Roll 2284Y	Rngbk 2255Z Roll 2285Z	Rngbk 2256Mc Roll 2286Mc			

**RINGBOOK** (24 labels/sheet)  
Binder only for starter kit-Item # MBINDER  
Index set only for starter kit-Item # MINDEX

**Individual Letters**  
(see label number) 240 labels

**Complete Set** 2259SET  
27 packs/6,480 labels

**Starter Kit** 2257SK  
Binder, Indexes, 3,471 assorted labels

**Refill Kit** 2258RK  
3,120 assorted labels (alpha only)

**ROLL** (500 labels/roll)  
**Individual Letters**  
(see label number) 500 labels

**Complete Set** 2289SET  
27 packs/13,500 labels

# Alphabetic Color Coded Labels

**1700 Series**  
 POS® 2000 Compatible  
 15/16" H x 1-5/8" W  
 (Polylaminated)

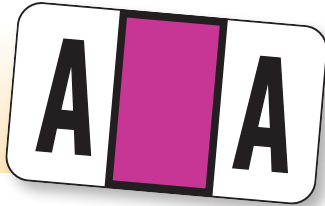

**1900 Series**  
 POS® 3300/3400 Compatible,  
 15/16" H x 1-5/8" W  
 (Polylaminated)

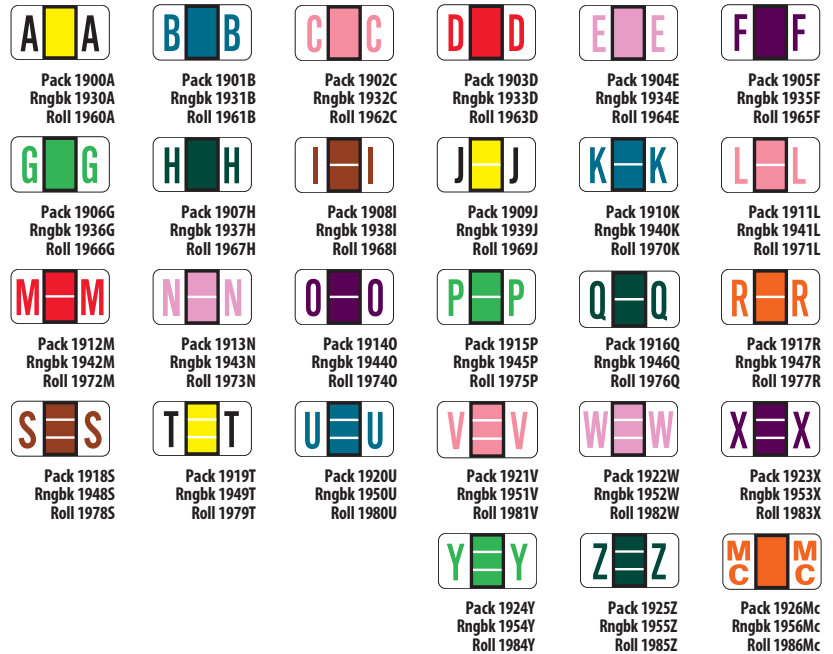

**PACK (9 labels/sheet)**  
 Kit box only for starter kit-Item # BBOX  
 Index set for starter kit-Item # BINDEX  
**Individual Letters**  
 (see label number) 225 labels  
**Complete Set 1929SET**  
 27 packs/6,075 labels  
**Starter Kit 1927SK**  
 File box, indexes, 2,898 assorted labels

**Refill Kit 1928RK**  
 2,898 assorted labels  
**RINGBOOK (24 labels/sheet)**  
 Binder only for starter kit-Item # MBINDER  
 Index set only for starter kit-Item # MINDEX  
**Individual Letters**  
 (see label number) 240 labels  
**Complete Set 1959SET**  
 27 packs/6,480 labels

**Starter Kit 1957SK**  
 Binder, indexes, 3,120 assorted labels  
**Refill Kit 1958RK**  
 3,120 assorted labels  
**ROLL (500 labels/roll)**  
**Individual Letters**  
 (see label number)  
**Complete Set 1989SET**  
 27 rolls, display unit, 13,500 labels

**RINGBOOK (24 labels/sheet)**  
 Binder only for starter kit-Item # MBINDER  
 Index set only for starter kit-Item # MINDEX  
**Individual Letters (see label number) 240 labels**  
**Complete Set 1759SET 27 packs/6,480 labels**  
**Starter Kit 1757SK Binder, indexes, 3,120 assorted labels**  
**Refill Kit 1758RK 3,120 assorted labels**

**2000 Series**  
 POS® 3700/3800 Compatible  
 1-1/2" H x 1-1/2" W (Polylaminated)

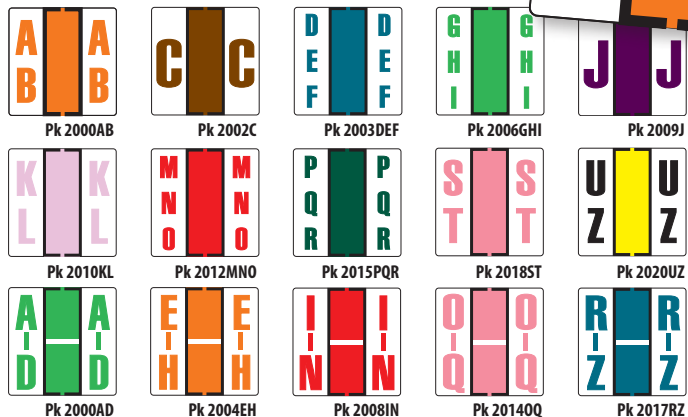

**PACK (sold in sets only) 5 labels/sheet**  
**3700 Compatible/Complete Set 2029SET**  
 (100 per package/10 packages)

**3800 Compatible/Complete Set 2039SET**  
 (100 per package/5 packages)





























# Alphabetic Color Coded Labels



## 3200 Series

PFSI/In-Health® 5700 Compatible  
15/16" H x 1-5/8" W (Poly laminated)



			
Pack 3200A Roll 3260A	Pack 3201B Roll 3261B	Pack 3202C Roll 3262C	Pack 3203D Roll 3263D
			
Pack 3204E Roll 3264E	Pack 3205F Roll 3265F	Pack 3206G Roll 3266G	Pack 3207H Roll 3267H
			
Pack 3208I Roll 3268I	Pack 3209J Roll 3269J	Pack 3210K Roll 3270K	Pack 3211L Roll 3271L
			
Pack 3212M Roll 3272M	Pack 3213N Roll 3273N	Pack 3214O Roll 3274O	Pack 3215P Roll 3275P
			
Pack 3216Q Roll 3276Q	Pack 3217R Roll 3277R	Pack 3218S Roll 3278S	Pack 3219T Roll 3279T
			
Pack 3220U Roll 3280U	Pack 3221V Roll 3281V	Pack 3222W Roll 3282W	Pack 3223X Roll 3283X
			
Pack 3224Y Roll 3284Y	Pack 3225Z Roll 3285Z	Pack 3226Mc Roll 3286Mc	

**PACK (9 labels/sheet)**

Kit box only for starter kit-Item # BBOX  
Index set for starter kit-Item # BINDEX

**Individual Letters**

(see label number) 225 labels

**Complete Set 3229SET**

27 packs/6,075 labels

**Starter Kit 3227SK**

File box, Indexes,  
2,898 assorted labels

**Refill Kit 3228RK**

2,898 assorted labels

**ROLL (500 labels/roll)**



















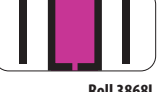







**Individual Letters**  
(see label number) 500 labels

**Complete Set 3289SET**

27 rolls, display unit,  
13,500 labels

## 3800 Series

Reynolds and Reynolds®  
RF Compatible  
3/4" H x 1-1/2" W (Poly laminated)

		
Roll 3860A Rngbk 3830A	Roll 3861B Rngbk 3831B	Roll 3862C Rngbk 3832C
		
Roll 3863D Rngbk 3833D	Roll 3864E Rngbk 3834E	Roll 3865F Rngbk 3835F
		
Roll 3866G Rngbk 3836G	Roll 3867H Rngbk 3837H	Roll 3868I Rngbk 3838I
		
Roll 3869J Rngbk 3839J	Roll 3870K Rngbk 3840K	Roll 3871L Rngbk 3841L
		
Roll 3872M Rngbk 3842M	Roll 3873N Rngbk 3843N	Roll 3874O Rngbk 3844O
		
Roll 3875P Rngbk 3845P	Roll 3876Q Rngbk 3846Q	Roll 3877R Rngbk 3847R
		
Roll 3878S Rngbk 3848S	Roll 3879T Rngbk 3849T	Roll 3880U Rngbk 3850U
		
Roll 3881V Rngbk 3851V	Roll 3882W Rngbk 3852W	Roll 3883X Rngbk 3853X
		
Roll 3884Y Rngbk 3854Y	Roll 3885Z Rngbk 3855Z	Roll 3886Mc Rngbk 3856Mc

**RINGBOOK (27 labels/sheet)**

Binder only for starter kit-Item # MBINDER  
Index set only for starter kit-Item # MINDEX

**Individual Letters**

(see label number) 270 labels

**Complete Set 3859SET, 27 packs/7,290 labels**

**Starter Kit 3857SK, Binder, Indexes, 3,510 labels**

**Refill Kit 3858RK, 3,510 assorted labels**

**ROLL (500 labels/roll)**

**Individual Letters**  
(see label number) 500 labels

**Complete Set 3889SET**

27 rolls, display unit,  
13,500 labels





# Alphabetic Color Coded Labels

## 2800 Series

Smead<sup>®</sup> ACC/ACCS Compatible,  
1" H x 1-5/8" W (Poly laminated)

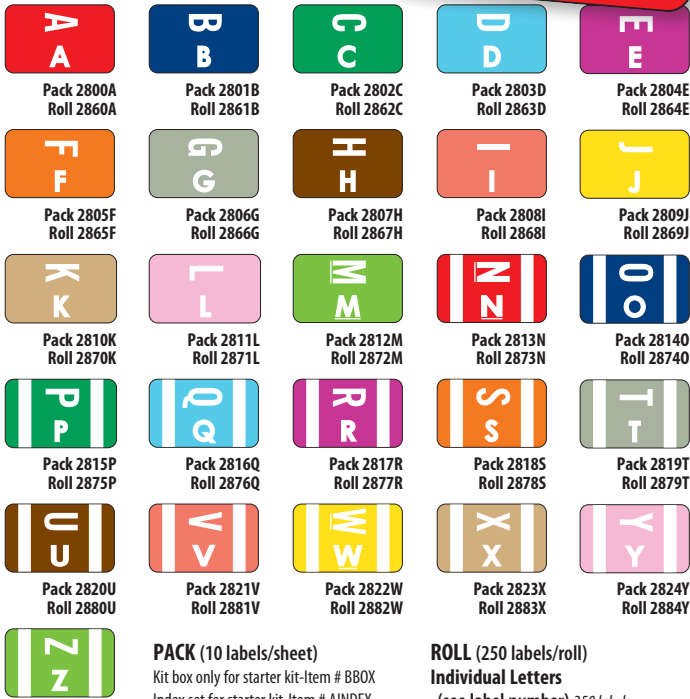
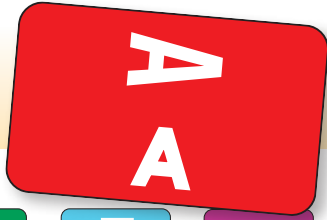

**PACK** (10 labels/sheet)

Kit box only for starter kit-Item # BBOX  
Index set for starter kit-Item # AINDEX

**Individual Letters**  
(see label number) 100 labels

**Complete Set** 2829SET

26 packs/2,600 labels

**Starter Kit** 2827SK

File box, Indexes, 2,200 assorted labels

**Refill Kit** 2828RK

2,200 assorted labels

**ROLL** (250 labels/roll)

**Individual Letters**  
(see label number) 250 labels

**Complete Set** 2889SET

26 rolls, display unit, 6,500 labels

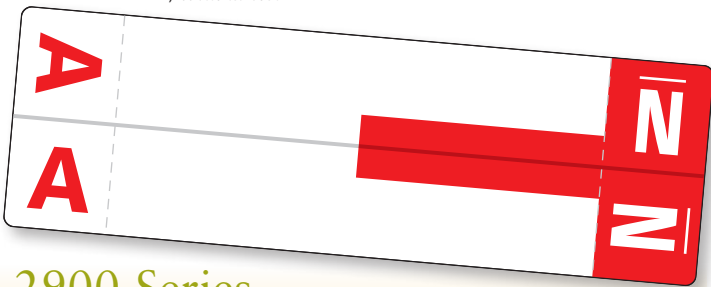

## 2900 Series

Smead<sup>®</sup> NCC Compatible,  
1-5/32" H x 3-5/8" W (Matte Paper)

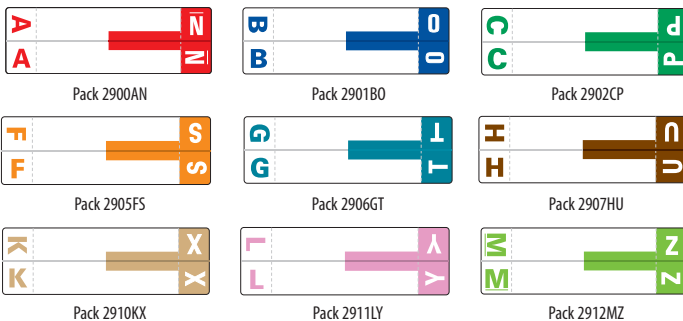

## 1200 Series

Smead<sup>®</sup> BCCR/BCCS Compatible,  
1" H x 1-1/4" W (Poly laminated)

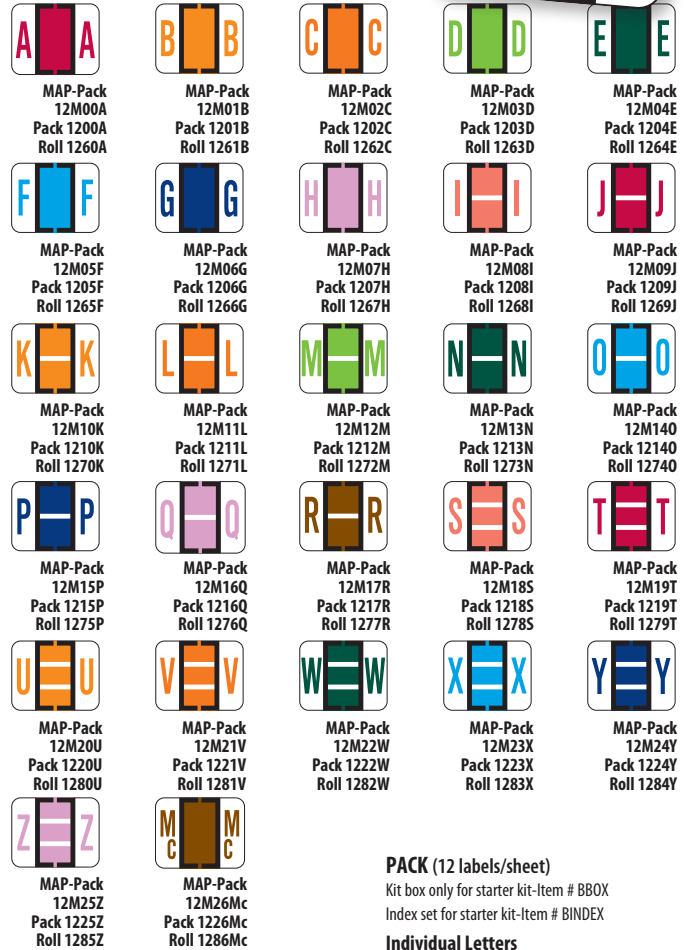

**PACK** (12 labels/sheet)

Kit box only for starter kit-Item # BBOX  
Index set for starter kit-Item # BINDEX

**Individual Letters**

(see label number) 120 labels

**Complete Set** 1229SET

27 packs/3,240 labels

**Starter Kit** 1227SK

File box, Indexes, 2,484 assorted labels

**Refill Kit** 1228RK

2,484 assorted labels

**ROLL** (500 labels/roll)

**Individual Letters**

(see label number) 500 labels

**Complete Set** 1289SET

27 rolls, display unit, 13,500 labels

**MAP-PACK** (12 labels/sheet)

Kit box only for starter kit-Item # BBOX  
Index set for starter kit-Item # BINDEX

**Individual Letters**

(see label number) 132 labels

**Complete Set** 12M29SET

27 packs/3,564 labels

**Starter Kit** 12M27SK

File box, Indexes, 2,076 assorted labels

**Refill Kit** 12M28RK

2,076 assorted labels

**PACKS** (5 labels/sheet)

Kit box only for starter kit-Item # BBOX  
Index set for starter kit-Item # DINDEX

**Individual Letters** (see label number) 100 labels

**Complete Set** 2929SET

13 packs/1,300 labels

**Starter Kit** 2927SK File box, Indexes, 1,500 assorted labels

**Refill Kit** 2928RK 1,500 assorted labels

# Alphabetic Color Coded Labels

## 1500 Series

Safeguard® 511/514 Compatible,  
15/16" H x 1-5/8" W  
(Polylaminated)



Rngbk 1530A Roll 1560A	Rngbk 1531B Roll 1561B	Rngbk 1532C Roll 1562C	Rngbk 1533D Roll 1563D	Rngbk 1534E Roll 1564E
Rngbk 1535F Roll 1565F	Rngbk 1536G Roll 1566G	Rngbk 1537H Roll 1567H	Rngbk 1538I Roll 1568I	Rngbk 1539J Roll 1569J
Rngbk 1540K Roll 1570K	Rngbk 1541L Roll 1571L	Rngbk 1542M Roll 1572M	Rngbk 1543N Roll 1573N	Rngbk 1544O Roll 1574O
Rngbk 1545P Roll 1575P	Rngbk 1546Q Roll 1576Q	Rngbk 1547R Roll 1577R	Rngbk 1548S Roll 1578S	Rngbk 1549T Roll 1579T
Rngbk 1550U Roll 1580U	Rngbk 1551V Roll 1581V	Rngbk 1552W Roll 1582W	Rngbk 1553X Roll 1583X	Rngbk 1554Y Roll 1584Y
Rngbk 1555Z Roll 1585Z	Rngbk 1556Mc Roll 1586Mc			

**RINGBOOK** (24 labels/sheet)  
Binder only for starter kit-Item # MBINDER  
Index set only for starter kit-Item # MINDEX  
**Individual Letters**  
(see label number) 240 labels  
**Complete Set 1559SET**  
27 packs/6,480 labels  
**Starter Kit 1557SK**  
Binder, Indexes, 3,471 assorted labels

**Refill Kit 1558RK**  
3,120 assorted labels (ALPHA only)  
**ROLL** (500 labels/roll)  
**Individual Letters**  
(see label number) 500 labels  
**Complete Set 1589SET**  
27 rolls, display unit, 13,500 labels

## 3500 Series

Traco® 1000/1100 Compatible  
15/16" H x 1-5/8" W  
(Polylaminated)



Rngbk 3530A Roll 3560A	Rngbk 3531B Roll 3561B	Rngbk 3532C Roll 3562C	Rngbk 3533D Roll 3563D	Rngbk 3534E Roll 3564E
Rngbk 3535F Roll 3565F	Rngbk 3536G Roll 3566G	Rngbk 3537H Roll 3567H	Rngbk 3538I Roll 3568I	Rngbk 3539J Roll 3569J
Rngbk 3540K Roll 3570K	Rngbk 3541L Roll 3571L	Rngbk 3542M Roll 3572M	Rngbk 3543N Roll 3573N	Rngbk 3544O Roll 3574O
Rngbk 3545P Roll 3575P	Rngbk 3546Q Roll 3576Q	Rngbk 3547R Roll 3577R	Rngbk 3548S Roll 3578S	Rngbk 3549T Roll 3579T
Rngbk 3550U Roll 3580U	Rngbk 3551V Roll 3581V	Rngbk 3552W Roll 3582W	Rngbk 3553X Roll 3583X	Rngbk 3554Y Roll 3584Y
Rngbk 3555Z Roll 3585Z	Rngbk 3556Mc Roll 3586Mc	Rngbk 3556ST Roll 3586ST		

**RINGBOOK** (24 labels/sheet)  
Binder only for starter kit-Item # MBINDER  
Index set only for starter kit-Item # MINDEX  
**Individual Letters**  
(see label number) 240 labels  
**Complete Set 3559SET**  
28 packs/6,720 labels  
**Starter Kit 3557SK**  
Binder, indexes, 3,096 assorted labels

**Refill Kit 3558RK**  
3,096 assorted labels  
**ROLL** (500 labels/roll)  
**Individual Letters**  
(see label number) 500 labels  
**Complete Set 3589SET**  
28 rolls, display unit, 14,000 labels

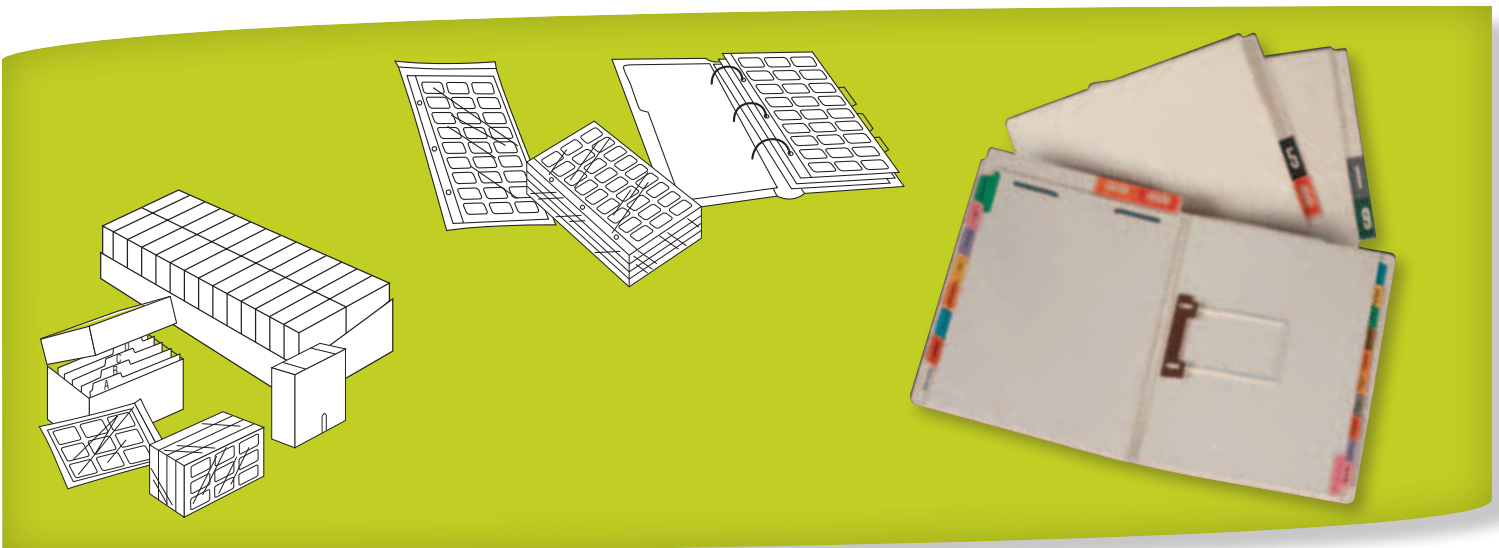

# Alphabetic Color Coded Labels

## 1000 Series

TAB® 1283/1286 Compatible  
1" H x 1-1/4" W (Vinyl)



Pack 1000A  
Ringbook 1030A  
Roll 1060A



Pack 1001B  
Ringbook 1031B  
Roll 1061B



Pack 1002C  
Ringbook 1032C  
Roll 1062C



Pack 1003D  
Ringbook 1033D  
Roll 1063D



Pack 1004E  
Ringbook 1034E  
Roll 1064E



Pack 1005F  
Ringbook 1035F  
Roll 1065F



Pack 1006G  
Ringbook 1036G  
Roll 1066G

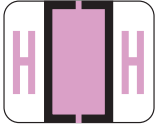

Pack 1007H  
Ringbook 1037H  
Roll 1067H

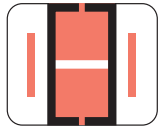

Pack 1008I  
Ringbook 1038I  
Roll 1068I



Pack 1009J  
Ringbook 1039J  
Roll 1069J



Pack 1010K  
Ringbook 1040K  
Roll 1070K



Pack 1011L  
Ringbook 1041L  
Roll 1071L

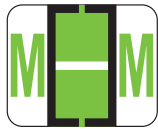

Pack 1012M  
Ringbook 1042M  
Roll 1072M



Pack 1013N  
Ringbook 1043N  
Roll 1073N

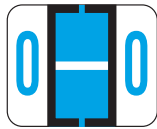

Pack 1014O  
Ringbook 1044O  
Roll 1074O



Pack 1015P  
Ringbook 1045P  
Roll 1075P

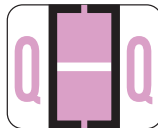

Pack 1016Q  
Ringbook 1046Q  
Roll 1076Q



Pack 1017R  
Ringbook 1047R  
Roll 1077R

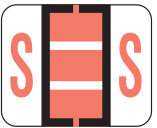

Pack 1018S  
Ringbook 1048S  
Roll 1078S



Pack 1019T  
Ringbook 1049T  
Roll 1079T



Pack 1020U  
Ringbook 1050U  
Roll 1080U



Pack 1021V  
Ringbook 1051V  
Roll 1081V



Pack 1022W  
Ringbook 1052W  
Roll 1082W

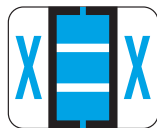

Pack 1023X  
Ringbook 1053X  
Roll 1083X



Pack 1024Y  
Ringbook 1054Y  
Roll 1084Y

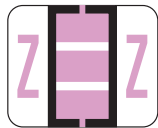

Pack 1025Z  
Ringbook 1055Z  
Roll 1085Z



Pack 1026Mc  
Ringbook 1056Mc  
Roll 1086Mc

**PACK** (9 labels/sheet)  
Kit box only for starter kit-Item # BBOX  
Index set for starter kit-Item # BINDEX

**Individual Letters**  
(see label number) 225 labels

**Complete Set 1029SET**  
27 packs/6,075 labels

**Starter Kit 1027SK**  
File box, Indexes, 2,898 assorted labels

**Refill Kit 1028RK**  
2,898 assorted labels

**RINGBOOK** (50 labels/sheet)  
Binder only for starter kit-Item # LBINDER  
Index set only for starter kit-Item # LINDEX

**Individual Letters**  
(see label number) 500 labels

**Complete Set 1059SET**  
27 packs/13,500 labels

**Starter Kit 1057SK**  
Binder, Indexes, 3,200 assorted labels

**Refill Kit 1058RK**  
3,200 assorted labels

**ROLL** (500 labels/roll)  
**Individual Letters**  
(see label number) 500 labels

**Complete Set 1089SET**  
27 rolls, display unit, 13,500 labels

## 1100 Series

TAB® 1278 Compatible, 1/2" H x 1" W (Vinyl)



Roll 1160A



Roll 1161B



Roll 1162C



Roll 1163D



Roll 1164E



Roll 1165F



Roll 1166G



Roll 1167H



Roll 1168I



Roll 1169J



Roll 1170K



Roll 1171L



Roll 1172M



Roll 1173N



Roll 1174O



Roll 1175P



Roll 1176Q



Roll 1177R

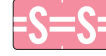

Roll 1178S



Roll 1179T



Roll 1180U



Roll 1181V



Roll 1182W



Roll 1183X



Roll 1184Y



Roll 1185Z

**ROLL** (500 labels/roll)  
**Individual Letters**  
(see label number) 500 labels  
**Complete Set 1189SET**  
26 rolls, 13,000 labels

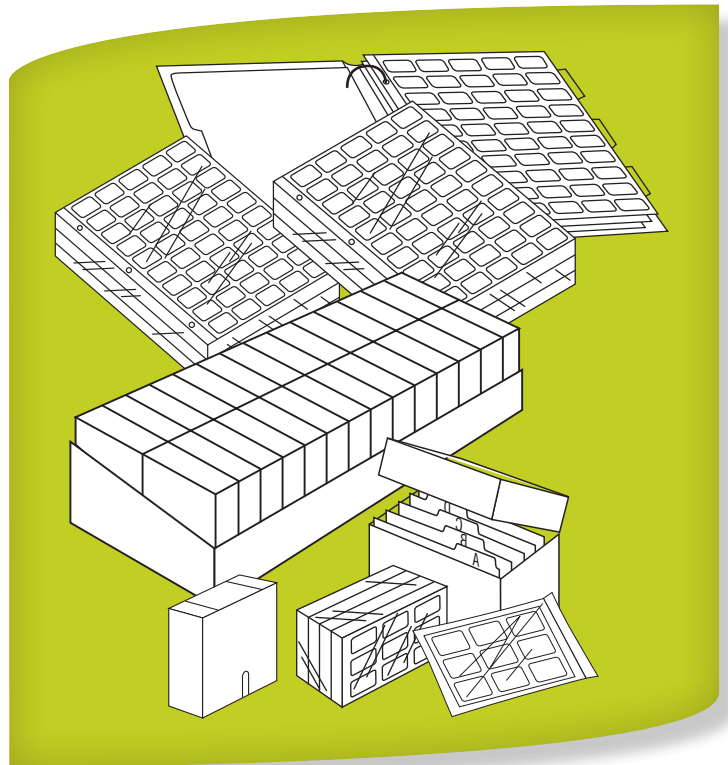

# Numeric Color Coded Labels

## 40800 SERIES

Ames® Compatible  
1-7/8" H x 1-7/8" W  
(Polylaminated)

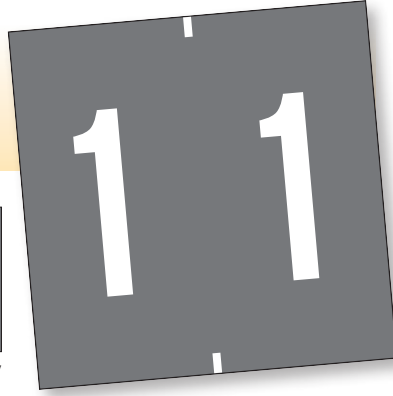

Roll 40860R



Roll 40861GY



Roll 40862BE



Roll 40863OR



Roll 40864P



Roll 40865BK



Roll 40866Y



Roll 40867BN

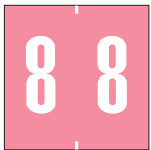

Roll 40868PK



Roll 40869GN

**ROLL (500 labels)**  
**Individual Rolls**  
(see label number) 500 labels  
**Complete Set 40889SET**  
10 rolls, 5,000 labels

## 5400 SERIES

Barkley® NBKM & SYCOM®  
Compatible  
1" H x 1-1/2" W  
(Polylaminated)



MAP-Pack  
54M00R  
Pack 5400R  
Roll 5460R



MAP-Pack  
54M05BE  
Pack 5405BE  
Roll 5465BE



MAP-Pack  
54M01PK  
Pack 5401PK  
Roll 5461PK



MAP-Pack  
54M06L  
Pack 5406L  
Roll 5466L



MAP-Pack  
54M02Y  
Pack 5402Y  
Roll 5462Y



MAP-Pack  
54M07BN  
Pack 5407BN  
Roll 5467BN



MAP-Pack  
54M03DOR  
Pack 5403DOR  
Roll 5463DOR



MAP-Pack  
54M08GY  
Pack 5408GY  
Roll 5468GY



MAP-Pack  
54M04GN  
Pack 5404GN  
Roll 5464GN



MAP-Pack  
54M09GD  
Pack 5409GD  
Roll 5469GD

**MAP-PACK (9 labels/sheet)**  
Kit box only for starter kit-Item # BBOX  
Index set for starter kit-Item # BINDEX#

**Individual Letters**  
(see label number) 126 labels

**Complete Set 54M29SET**  
10 packs/1,260 labels

**Starter Kit 54M30SK**  
File box, indexes, 2,520  
assorted labels

**PACK (9 labels /sheet)**  
Kit box only for starter kit-Item # BBOX  
Index set for starter kit-Item # BINDEX#

**Individual Packs**  
(see label number) 225 labels

**Complete Set 5429SET**  
10 packs/2,250 labels

**ROLL (500 labels/roll)**  
**Individual Rolls**  
(see label number)

**Complete Set 5489SET**  
10 rolls, display unit, 5000 labels

## 40500 SERIES

Barkley® NBRM® Compatible  
1-1/2" H x 1-1/2" W (Polylaminated)

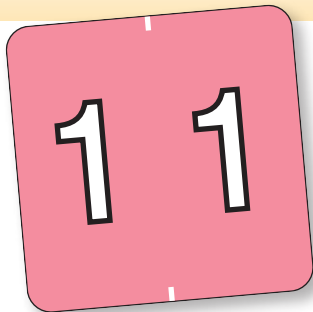

Roll 40560R



Roll 40561PK



Roll 40562Y



Roll 40563DOR



Roll 40564GN



Roll 40565BE



Roll 40566LV



Roll 40567BN



Roll 40568GY



Roll 40569GD

**ROLL (1000 labels/roll)**  
**Individual Rolls**  
(see label number)  
**Complete Set 40589SET**  
10 rolls,  
display unit, 10,000 labels

## 40200 SERIES

Barkley® NBAM & NBWM®  
Compatible  
1/2" H x 1-1/2" W (Polylaminated)

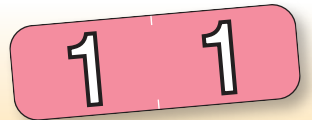

Roll 40260R

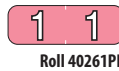

Roll 40261PK



Roll 40262Y



Roll 40263DOR



Roll 40264GN



Roll 40265BE



Roll 40266LV



Roll 40267BN

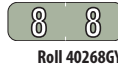

Roll 40268GY



Roll 40269GD

**ROLL (500 labels/roll)**  
**Individual Rolls**  
(see label number)  
**Complete Set 40289SET**  
10 rolls, display unit,  
5,000 labels  
**40489SET (B&W)**  
10 rolls, display unit,  
10,000 labels)

## 40400 SERIES

Barkley® NBAM & NBWM®  
Compatible  
1/2" H x 1-1/2" W (Polylaminated)

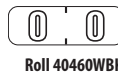

Roll 40460WBK

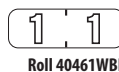

Roll 40461WBK

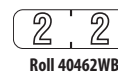

Roll 40462WBK



Roll 40463WBK

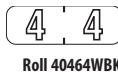

Roll 40464WBK

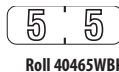

Roll 40465WBK



Roll 40466WBK



Roll 40467WBK

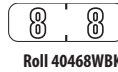

Roll 40468WBK



Roll 40469WBK











**ROLL (1,000 labels)**  
**Individual Rolls**  
(see label number)  
**Complete Set 40489SET (B&W)**  
10 rolls, display unit,  
10,000 labels)

# Numeric Color Coded Labels

## 5100 SERIES

COL'R'TAB® 11000  
Compatible 1" H x 1-1/2" W  
(Polylaminated)









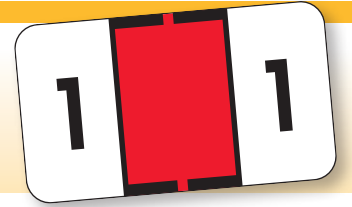

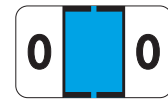

 Roll 5160Y	 Roll 5161LBE	 Roll 5162R	 Roll 5163LGN
 Roll 5164GY	 Roll 5165GD	 Roll 5166DGN	 Roll 5167DBE
 Roll 5168OR	 Roll 5169BK	<p><b>ROLL (500 labels)</b> Individual Rolls (see label number) 500 labels <b>Complete Set 5189SET</b> 10 rolls, display unit, 5,000 labels</p>	

## 4500 Series

Control-O-Fax®  
96-00-1000 Compatible  
15/16" H x 1-5/8" W (Vinyl)



 Rngbk 4530LBE	 Rngbk 4531R
 Rngbk 4532LGN	 Rngbk 4533P
 Rngbk 4534OR	 Rngbk 4535DBE
 Rngbk 4536Y	 Rngbk 4537M
 Rngbk 4538A	 Rngbk 4539DGN

**RINGBOOK (24 labels/sheet)**  
Binder only for starter kit-Item # MBINDER  
**Individual Numbers**  
(see label number) 240 labels  
**Complete Set 4559SET**  
10 packs/2,400 labels

## 50200 Series

Datafile® DF790  
Compatible  
15/16" H x 1-1/4" W  
(Polylaminated)













 Roll 50260PK	 Roll 50261R	 Roll 50262LOR	 Roll 50263DOR
 Roll 50264LGN	 Roll 50265DGN	 Roll 50266LBE	 Roll 50267P
 Roll 50268LV	 Roll 50269BN	<p><b>ROLL (500 labels/roll)</b> Individual Rolls (see label number) 500 labels <b>Complete Set 50289SET</b> 10 rolls, display unit, 5,000 labels</p>	

## 5000 SERIES

GBS® (VRE) 8860 Compatible  
1-5/16" H x 1-1/4" W (Polylaminated)













 Roll 5060Y	 Roll 5061BE	 Roll 5062PK	 Roll 5063P
 Roll 5064OR	 Roll 5065BR	 Roll 5066GN	 Roll 5067GY
 Roll 5068R	 Roll 5069BK	<p><b>ROLL (500 labels)</b> Individual Rolls (see label number) 500 labels <b>Complete Set 5089SET</b> 10 rolls, display unit, 5,000</p>	

## 8300 SERIES

Colwell Jewel Tone Compatible  
1" H x 1-1/2" W (Polylaminated)



 Roll 8360Y	 Roll 8361R	 Roll 8362GN	 Roll 8363BN	 Roll 8364BE
 Roll 8365V	 Roll 8366OR	 Roll 8367LGN	 Roll 8368P	 Roll 8369GD

**ROLL**  
(500 labels/roll)  
Individual Rolls  
(see label number)

**Complete Set 8389SET**  
10 rolls, display unit,  
5,000 labels

# Numeric Color Coded Labels

## 4300 SERIES

JETER® 7300 Compatible  
15/16"H x 1-5/8"W  
(Polylaminated)

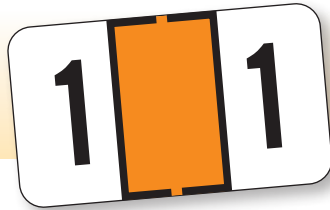

Roll 4360T



Roll 4361OR



Roll 4362DGN



Roll 4363P



Roll 4364LBE



Roll 4365R



Roll 4366LGN



Roll 4367BK

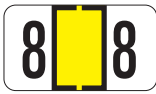

Roll 4368Y



Roll 4369DBE

**ROLL (500 labels/roll)**

**Individual Rolls**  
(see label number) 500 labels

**Complete Set 4389SET**  
10 rolls, display unit, 5,000 labels

## 4400 SERIES

JETER® 7600 Compatible  
15/16"H x 1-5/8"W  
(Polylaminated)

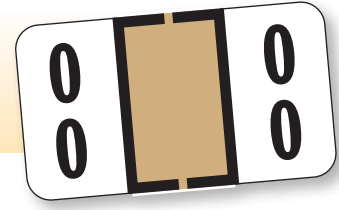

Roll 4460T



Roll 4461OR



Roll 4462DGN



Roll 4463P



Roll 4464LBE



Roll 4465R



Roll 4466LGN



Roll 4467BK



Roll 4468Y



Roll 4469DBE

**ROLL (500 labels/roll)**

**Individual Rolls**  
(see label number) 500 labels

**Complete Set 4489SET** 1 roll each series  
Series repeats 50 times per roll  
10 rolls, display unit, 5,000 labels

## 4600 SERIES

JETER® 3000/7400  
Compatible  
3/4"H x 1-1/2"W  
(Polylaminated)

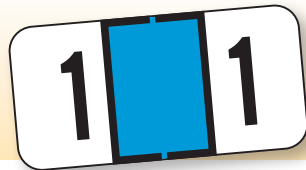

Rngbk 4630LGN  
Roll 4660LGN



Rngbk 4631LBE  
Roll 4661LBE



Rngbk 4632BN  
Roll 4662BN



Rngbk 4633Y  
Roll 4663Y



Rngbk 4634P  
Roll 4664P



Rngbk 4635R  
Roll 4665R



Rngbk 4636BK  
Roll 4666BK



Rngbk 4637OR  
Roll 4667OR



Rngbk 4638DBE  
Roll 4668DBE



Rngbk 4639W  
Roll 4669W

**RINGBOOK (27 labels/sheet)**

Binder only for starter kit-Item # MBINDER

**Individual Packs**  
(see label number) 270 labels

**Complete Set 4659SET**  
10 packs/2,700 labels

**ROLL (500 labels/roll)**

**Individual Rolls**  
(see label number) 500 labels

**Complete Set 4689SET**  
10 rolls, display unit, 5,000 labels

## 4800 SERIES

JETER® 6100 Compatible  
15/16"H x 1-5/8"W  
(Polylaminated)

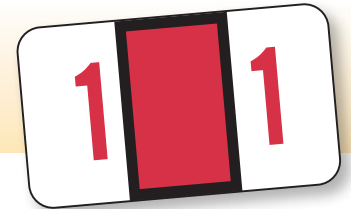

Pack 4800PK  
Roll 4860PK



Pack 4801R  
Roll 4861R



Pack 4802LOR  
Roll 4862LOR



Pack 4803DOR  
Roll 4863DOR



Pack 4804LGN  
Roll 4864LGN



Pack 4805DGN  
Roll 4865DGN



Pack 4806LBE  
Roll 4866LBE



Pack 4807P  
Roll 4867P

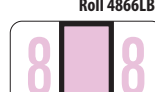

Pack 4808L  
Roll 4868L



Pack 4809BN  
Roll 4869BN



Pack 4802LBE\*  
Roll 4862LBE\*



Pack 4806Y\*  
Roll 4866Y\*

**PACK (9 labels/sheet)**

Kit box only for starter kit-Item # BBOX  
Index set for starter kit-Item # BINDEX#

**Individual Packs**  
(see label number) 225 labels

**Complete Sets 4829SETB**  
10 packs/2,250 labels (Orange 2/Blue 6)  
\*4829SETY 10 packs/2,250 labels  
(Blue 2/Yellow 6)

**ROLL (500 labels/roll)**

**Individual Rolls**  
(see label number) 500 labels

**Complete Sets 4889SETB**  
10 rolls/5,000 labels (Orange 2/Blue 6)  
\*4889SETY 10 rolls/5,000 labels  
(Blue 2/Yellow 6)

# Numeric Color Coded Labels

## 5300 SERIES

JETER® 2600 Compatible  
15/16" H x 1-5/8" W  
(Polylaminated)

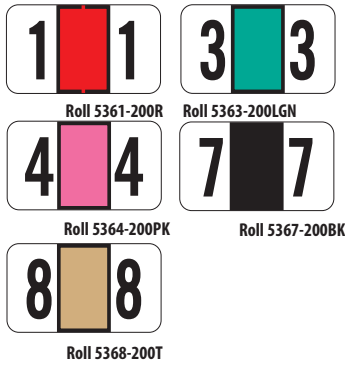
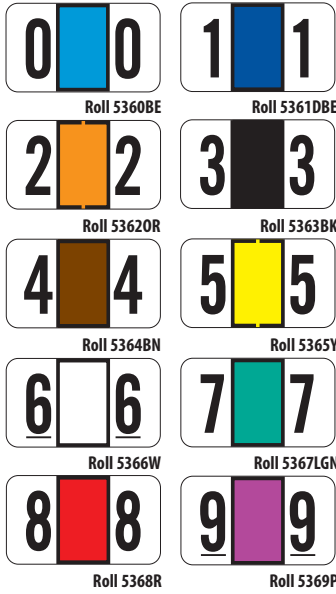
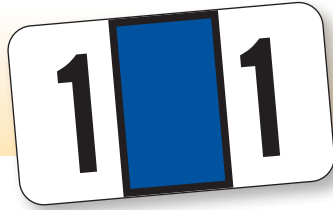

**ROLL (500 labels/roll)**  
**Individual Rolls**  
(see label number) 500 labels

**Complete Sets**  
5389SET 10 rolls/5,000 labels  
5389-200SET 10 rolls/5,000 labels  
(No. 1, 3, 4, 7, 8 are substituted)

## 40300 SERIES

JETER® 4500 Compatible  
3/4" H x 1-1/2" W  
(Polylaminated)

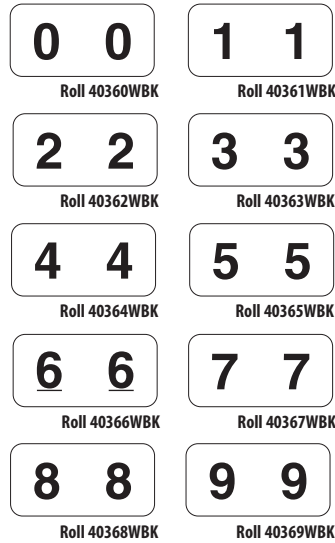

**ROLL (500 labels/roll)**  
**Individual Rolls**  
(see label number) 500 labels

**Complete Set 40389SET**  
10 rolls, display unit, 5,000 labels

## 5700 Series

PFSI™/IN-HEALTH™  
5200DX Compatible  
15/16" H x 1-5/8" W  
(Polylaminated)

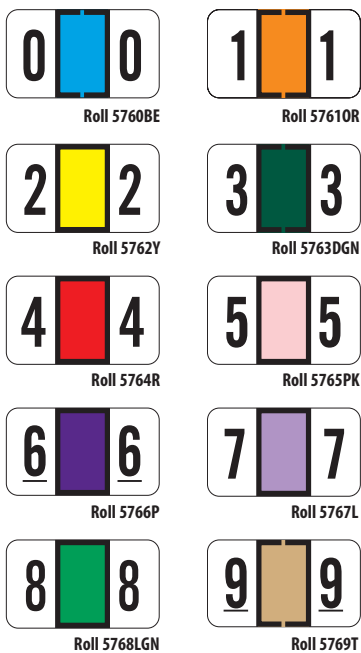

**ROLL (500 labels/roll)**  
**Individual Rolls**  
(see label number) 500 labels

**Complete Set 5789SET**  
10 rolls, display unit, 5,000 labels

## 50100 SERIES

JETER® 7700 Double "J"  
Compatible  
15/16" H x 1-5/8" W  
(Polylaminated)

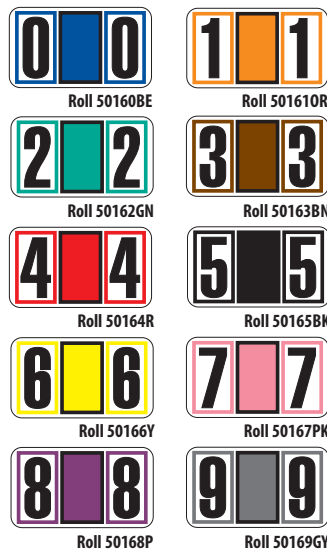

**ROLL (500 labels/roll)**  
**Individual Rolls**  
(see label number) 500 labels

**Complete Set 50189SET**  
10 rolls, display unit, 5,000 labels

# Numeric Color Coded Labels

## 4900 SERIES

POS® 3500 Compatible  
15/16" H x 1-5/8" W  
(Poly laminated)

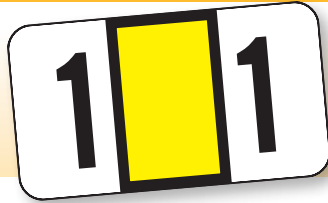

Roll 4960BN



Roll 4961Y



Roll 4962BE



Roll 4963PK



Roll 4964R



Roll 4965L



Roll 4966P



Roll 4967GN



Roll 4968DGN



Roll 4969OR

**ROLL (500 labels)**  
**Individual Rolls**  
(see label number) 500 labels  
**Complete Set 4989SET**  
10 rolls, display unit, 5,000 labels

## 5800 Series

Reynolds & Reynolds®  
RF Compatible  
7/8" H x 1-5/8" W  
(Poly laminated)

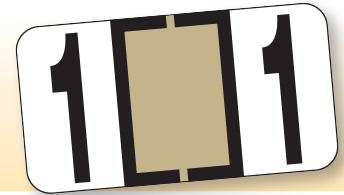

Rngbk 5830OR  
Roll 5860OR



Rngbk 5831GD  
Roll 5861GD



Rngbk 5830-200LG  
Roll 5860-200LG



Rngbk 5835-200OR  
Roll 5865-200OR



Rngbk 5832BE  
Roll 5862BE



Rngbk 5833Y  
Roll 5863Y

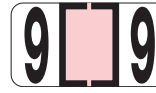

Rngbk 5839-200PK\*  
Roll 5869-200PK\*



Rngbk 5834BK  
Roll 5864BK



Rngbk 5835LGN  
Roll 5865LGN



Rngbk 5836R  
Roll 5866R



Rngbk 5837LBE  
Roll 5867LBE



Rngbk 5838P  
Roll 5868P



Rngbk 5839DGN  
Roll 5869DGN

**RINGBOOK (24 labels/sheet)**  
Binder only for starter kit-Item # MBINDER  
**Individual Numbers**  
(see label number) 240 labels

**Complete Sets**  
**5859SET**  
(10 packs/2,400 labels) (standard 0, 5, 9)  
**5859-200SET**  
(10 packs/2,400 labels) (alternate 0, 5, 9)

**Starter Kits**  
**5857SK** (Binder, indexes,  
2,400 labels) (standard 0, 5, 9)  
**5857-200SK** (Binder, indexes,  
2,400 labels) (alternate 0, 5, 9)

**ROLLS (500 labels/roll)**  
**Individual Rolls**  
(see label number) 500 labels  
**Complete Sets**  
**5889SET** (10 rolls, display unit,  
5,000 labels) (standard 0, 5, 9)  
**5889-200SET** (10 rolls, display unit,  
5,000 labels) (alternate 0, 5, 9)

## 5200 SERIES

Smead® BCCRN/BCCSN  
Compatible  
1"H x 1-1/4"W  
(Poly laminated)

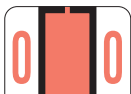
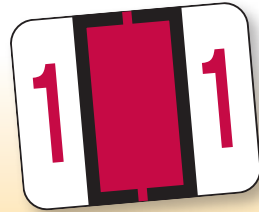

MAP-Pack 52M00PK  
Pack 5200PK  
Roll 5260PK



MAP-Pack 52M01R  
Pack 5201R  
Roll 5261R



MAP-Pack 52M02LOR  
Pack 5202LOR  
Roll 5262LOR



MAP-Pack 52M03DOR  
Pack 5203DOR  
Roll 5263DOR



MAP-Pack 52M04LGN  
Pack 5204LGN  
Roll 5264LGN



MAP-Pack 52M05DGN  
Pack 5205DGN  
Roll 5265DGN

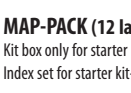

MAP-Pack 52M06BE  
Pack 5206BE  
Roll 5266BE



MAP-Pack 52M07P  
Pack 5207P  
Roll 5267P

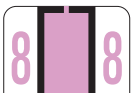

MAP-Pack 52M08L  
Pack 5208L  
Roll 5268L



MAP-Pack 52M09BN  
Pack 5209BN  
Roll 5269BN

**MAP-PACK (12 labels/sheet)**  
Kit box only for starter kit-Item # BBOX  
Index set for starter kit-Item # BINDEX#  
**Individual Packs**  
(see label number) 132 labels  
**Complete Set 52M29SET**  
10 packs/1,320 labels  
**Starter Kit 52M30SK**  
File box, indexes, 2,076 assorted labels

**PACK (12 labels/sheet)**  
Kit box only for starter kit-Item # BBOX  
Index set for starter kit-Item # BINDEX#  
**Individual Packs**  
(see label number) 120 labels  
**Complete Set 52Z9SET**  
10 packs/1,200 labels

**ROLL (500 labels/roll)**  
**Individual Rolls**  
(see label number) 500 labels  
**Complete Set 5289SET**  
10 rolls, display unit, 5,000 labels

## 40900 Series

Safeguard® 516  
Compatible  
15/16"H x 1-5/8"W  
(Poly laminated)



Roll 40960BN



Roll 40961R



Roll 40962LBE



Roll 40963LV



Roll 40964LGN



Roll 40965LOR



Roll 40966DGN



Roll 40967T



Roll 40968DBE



Roll 40969Y

**ROLL (500 labels/roll)**  
**Individual Rolls**  
(see label number) 500 labels  
**Complete Set 40989SET**  
10 rolls, display unit, 5,000 labels



# Numeric Color Coded Labels

## 5600 SERIES

Smead® LCC Compatible  
2"H x 1"W (Matte Paper)

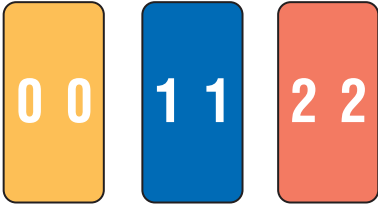

Roll 5660Y



Roll 5661LBE



Roll 5662PK



Roll 5663P



Roll 5664OR



Roll 5665BN



Roll 5666GN



Roll 5667GY



Roll 5668R



Roll 5669BK

**ROLL (250 labels/roll)**  
Individual Rolls  
(see label number) 250 labels  
**Complete Set 5689SET**  
10 rolls, display unit, 2,500 labels

## 4000 SERIES

TAB® 1382 Compatible  
1"H x 1-1/4"W (Vinyl)

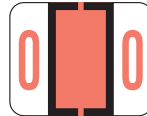

Roll 4060PK

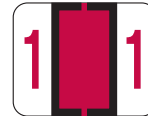

Roll 4061R



Roll 4062LOR



Roll 4063DOR



Roll 4064LGN



Roll 4065DGN

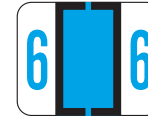

Roll 4066BE



Roll 4067P

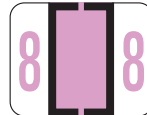

Roll 4068L



Roll 4069BN

**ROLL (500 labels/roll)**  
Individual Rolls  
(see label number)  
**Complete Set 4089SET**  
10 rolls, display unit, 5,000 labels

## 4100 SERIES

TAB® 1277 Compatible  
1/2"H x 1"W (Vinyl)



Roll 4160PK



Roll 4165DGN



Roll 4161R



Roll 4166BE



Roll 4162LOR



Roll 4167P



Roll 4163DOR

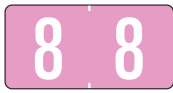

Roll 4168L



Roll 4164LGN



Roll 4169BN

**ROLL (500 labels/roll)**  
Individual Rolls  
(see label number)  
**Complete Set 4189SET**  
10 rolls, display unit, 5,000 labels

## 4200 SERIES

TAB® 1280 Compatible  
1/2"H x 1"W (Vinyl)



Roll 4260OR



Roll 4265BK



Roll 4261GN



Roll 4266GY



Roll 4262DBE



Roll 4267R



Roll 4263LBE



Roll 4268Y



Roll 4264BN



Roll 4269PK

**ROLL (500 labels/roll)**  
Individual Rolls  
(see label number)  
**Complete Set 4289SET**  
10 rolls, display unit,  
5,000 labels

# Year/Aging Color Coded Labels

**PMA**  
Fluorescent Series  
1-1/2" W x 3/4" H  
Polylaminated  
500/Roll



2011 • 0711FLGN  
2010 • 0710FLGN



2011 • 0711FLY  
2010 • 0710FLY



2011 • 0711FLPK  
2010 • 0710FLPK



2011 • 0711FLRD  
2010 • 0710FLRD



2011 • 0711FLOR  
2010 • 0710FLOR

**Best Tab**  
1-1/2" W x 3/4" H  
Polylaminated  
500/Roll

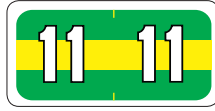

2011 • 0711GNY  
2010 • 0710GNY



2011 • 0711ORY  
2010 • 0710ORY

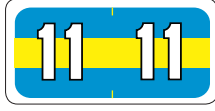

2011 • 0711BEY  
2010 • 0710BEY

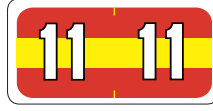

2011 • 0711RY  
2010 • 0710RY

**PMA**  
Holographic Series  
1-1/2" W x 3/4" H  
Polylaminated  
500/Roll



2011 • 0711HBE  
2010 • 0710HBE



2011 • 0711HGN  
2010 • 0710HGN



2011 • 0711HOR  
2010 • 0710HOR



2011 • 0711HV  
2010 • 0710HV



2011 • 0711HAQ  
2010 • 0710HAQ



2011 • 0711HRD  
2010 • 0710HRD



**Amerifile** 1-1/2" W x 3/4" H  
Polylaminated  
500/Roll • 0711VLT



**Col'R'Tab** 1-1/2" W x 3/4" H  
Polylaminated  
500/Roll • 0711LBE



**POS** 1-1/2" W x 3/4" H  
Kimdura  
500/Roll • 0710GR



**Barkley** 1-1/2" W x 3/4" H  
Polylaminated  
500/Roll • 0711PK



**Control-O-Fax** 1-1/2" W x 3/4" H  
Kimdura  
500/Roll • 0710BSW  
270/RB Pkg • 0410BSW



**POS** 1 1/2" W x 1/2" H  
Kimdura  
500/Roll • 0610BGW



**Ames** 1-7/8" W x 1-7/8" H  
Semi-Gloss  
2011 • 1000/Roll • 0811AMGY



**GBS/VRE** 1-1/2" W x 3/4" H  
Polylaminated  
500/Roll • 0711BE



**POS** 1-1/2" W x 3/4" H  
Kimdura  
500/Roll • 0710BGW  
270/RB Pkg • 0410BGW



**Ames** 1-3/4" W x 1/2" H  
Semi-Gloss  
2011 • 1000/Roll • 0611AMGY



**Jeter** 1-1/2" W x 3/4" H  
Polylaminated  
500/Roll • 0711YBK  
270/RB Pkg • 0411YBK



**POS** 1-1/2" W x 3/4" H  
Kimdura  
500/Roll • 0710WBR



**Patterson/Colwell** 1" W x 1/2" H  
500/Pkg • 0211RJTE



**Jeter - R Series** 1-1/2" W x 3/4" H  
Polylaminated  
500/Roll • 0710JRM



**Reynolds + Reynolds** 1-1/2" W x 3/4" H  
Polylaminated  
500/Roll • 0711RLV  
270/RB Pkg • 0411RLV



**Patterson/Colwell** 1/2" W x 1" H  
500/Pkg • 0211RJTT



**Patterson/Colwell** 1-1/2" W x 3/4" H  
500/Roll • 0711RJTE



**Jeter Proprietary** 1-1/2" W x 3/4" H  
Polylaminated  
500/Roll • 0710JYB  
270/RB Pkg • 0410JYB



**Safeguard** 1-1/2" W x 3/4" H  
Polylaminated  
500/Roll • 0711R  
270/RB Pkg • 0411R



**Patterson/Colwell** 3/4" W x 1-1/2" H  
500/Roll • 0711RJTT



**Smead End Tab**  
1" W x 1/2" H  
Polylaminated  
500/Roll • 0111LBE  
250/Pkg • 0011LBE



**Smead Top Tab**  
1/2" W x 1" H  
Polylaminated  
500/Roll • 0111LBT  
250/Pkg • 0011LBT



**Smead/Jeter** 1-1/2" W x 3/4" H  
Polylaminated  
500/Roll • 0711SMY



**TAB** 1-1/4" W x 3/4" H  
Kimdura  
500/Roll • 0711RD



**TAB** 1-1/8" W x 1/2" H  
Kimdura  
500/Roll • 0611RD



**Traco** 1-1/2" W x 3/4" H  
Polylaminated  
500/Roll • 0711RBK  
270/RB Pkg • 0411RBK



**Traco** 1" W x 1/2" H  
Polylaminated  
500/Roll • 0611RBK

# Month/Aging Color Coded Labels

**16100 Series**  
Barkley® MBLM Compatible  
3/4" H x 1-1/2" W  
(Polylaminated)

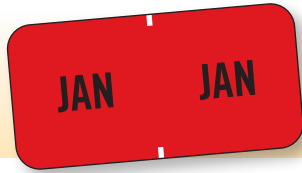

**18000 Series**  
JETER® 7000 Compatible  
15/16" H x 1-5/8" W  
(Polylaminated)

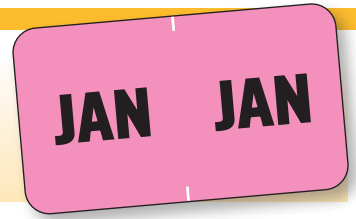

Roll 16161J

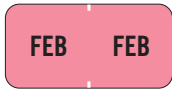

Roll 16162F



Roll 16163M



Roll 16164A



Roll 16165M



Roll 16166J

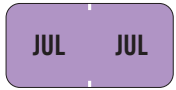

Roll 16167J



Roll 16168A



Roll 16169S



Roll 16170O



Roll 16171N



Roll 16172D



Pack 18001J



Pack 18002F



Pack 18003M



Pack 18004A



Pack 18005M



Pack 18006J



Pack 18007J



Pack 18008A



Pack 18009S



Pack 18010O



Pack 18011N



Pack 18012D

**ROLL (250 labels/roll)**  
Individual Months (see label number) 250 labels  
Complete Set 16189SET 3,000 labels

**PACK (9 labels/sheet)**  
Individual Months (see label number) 225 labels  
Complete Set 18029SET 2,700 labels  
Mini Set 18029MSET 2 sheets per month/216 labels

**15000 Series**  
Reynolds & Reynolds® RF Compatible  
3/4" H x 1-1/2" W (Polylaminated)

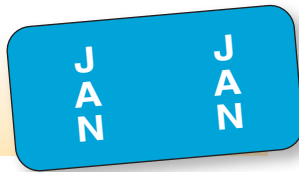

**16000 Series**  
Smead® ETS Compatible  
1/2" H x 1" W (Polylaminated)



Rngbk 15031J

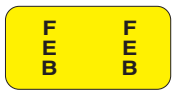

Rngbk 15032F



Rngbk 15033M



Rngbk 15034A



Rngbk 15035M



Rngbk 15036J



Rngbk 15037J



Rngbk 15038A

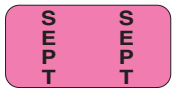

Rngbk 15039S



Rngbk 15040O



Rngbk 15041N



Rngbk 15042D



Pack 16001J



Pack 16002F



Pack 16003M



Pack 16004A



Pack 16005M



Pack 16006J



Pack 16007J



Pack 16008A



Pack 16009S



Pack 16010O



Pack 16011N



Pack 16012D

**RINGBOOK (27 labels/sheet)**  
Individual Months (see label number) 270 labels  
Complete Set 15059SET 3,240 labels

**PACK (25 labels/sheet)**  
Individual Months (see label number) 250 labels  
Complete Set 16029SET 3,000 labels

# Month and Year/Aging Color Coded Labels

## 17000 Series

SYCOM® 5918 Compatible  
3/4" H x 1-1/2" W (Polylaminated)



Roll 17061J



Roll 17062F



Roll 17063M



Roll 17064A



Roll 17065M



Roll 17066J



Roll 17067J



Roll 17068A



Roll 17069S



Roll 17070O



Roll 17071N



Roll 17072D

ROLL (500 labels/roll)

Individual Months (see label number) 500 labels

Complete Set 17089SET 6,000 labels

## 18600 Series

TAB® 1279 Compatible  
1/2" H x 1" W (Vinyl)



Roll 18601J



Roll 18602F



Roll 18603M



Roll 18604A



Roll 18605M



Roll 18606J



Roll 18607J



Roll 18608A



Roll 18609S



Roll 18610O



Roll 18611N



Roll 18612D

ROLL (500 labels/roll)

Individual Months (see label number) 500 labels

Complete Set 18689SET 6,000 labels

## 11000 Series

Jeter Compatible  
15/16" H x 1-5/8" W  
(Polylaminated)



11001J



11002F



11003M



11004A



11005M



11006J



11007J



11008A



11009S



11010O



11011N



11012D

ROLL (225/Pkg)

Individual Months (see label number)

225 labels

Complete Set 11029SET 2,700 labels

Complete Set 11029MSET 2,700 labels

## 11060 Series

Ames Compatible  
1" H x 1-3/4" W  
(Polylaminated)



11061J



11062F



11063M



11064A



11065M



11066J



11067J



11068A



11069S



11070O



11071N



11072D

ROLL (500 labels/roll)

(see label number) 500 labels

11089SET 6,000 labels

# Solid Color Designator Labels

## 6700 Series

Ames® L-A-00000  
Compatible  
1-7/8" H x 1-7/8" W  
(Semi-Gloss)



**ROLL (1,000 labels/roll)**

**Individual Colors**  
(see label number) 1,000 labels

**Complete Set 6789SET**  
11,000 labels

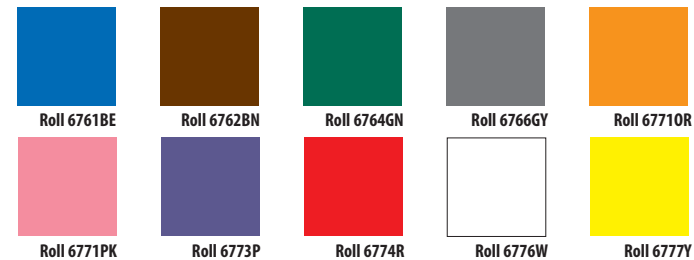

Roll 6760BK

## 6600 Series

GBS® (VRE) 8840 Compatible  
15/16" H x 1-1/4" W  
(Polylaminated)

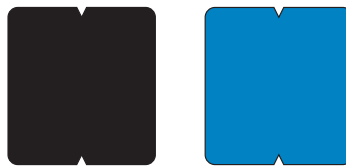
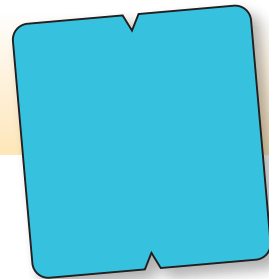

Rngbk 6630BK

Rngbk 6631BE

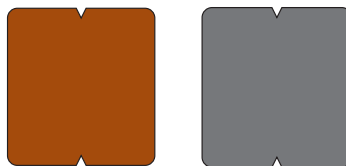

Rngbk 6632BN

Rngbk 6636GY

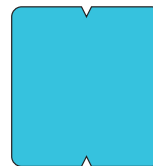

Rngbk 6639LBE

**PACK (10 labels/sheet)**

**Individual Colors**(see label number) 200 labels

**Complete Set 6659SET** 1,000 labels

## 63200 Series

Barkley® XBAM Compatible  
1/2" H x 1-1/2" W  
(Polylaminated)

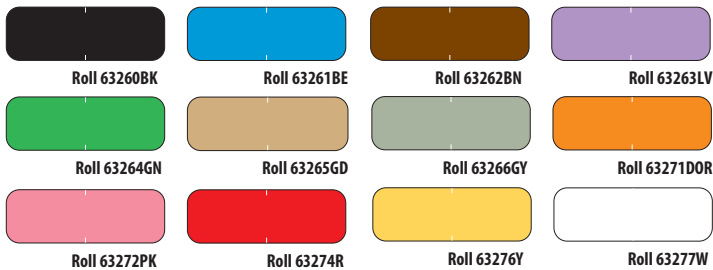
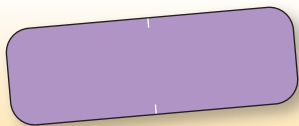

**ROLL (500 labels/roll)**

**Individual Colors**  
(see label number) 500 labels

**Complete Set**  
**63289SET** 6,000 labels

## 6300 Series

Smead® CC Compatible  
2" H x 1" W (Matte)

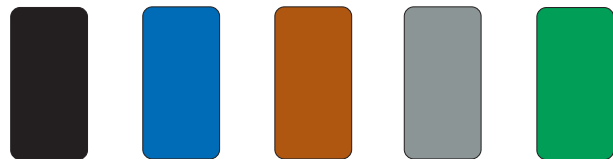
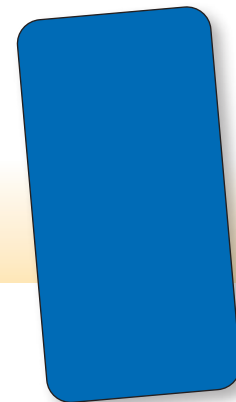

Roll 6360BK

Roll 6361BE

Roll 6362BN

Roll 6366GY

Roll 6370LGN

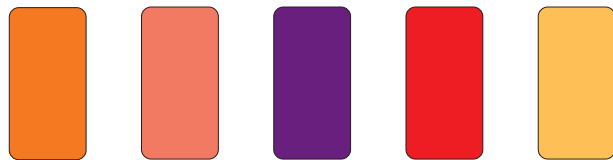

Roll 6371OR

Roll 6372PK

Roll 6373P

Roll 6374R

Roll 6377Y

**ROLL (250 labels/roll)**

**Individual Colors**(see number) 250 labels

**Complete Set 6389SET** 2,500 labels

## 6800 Series

Control-O-Fax®  
96-00-3000 Compatible  
3/4" H x 1-1/2" W (Vinyl)

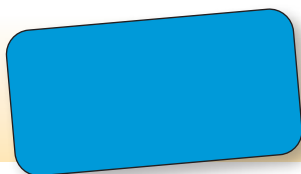

**RINGBOOK (27 labels/sheet)**

**Individual Colors**  
(see label number) 270 labels

# Solid Labels / Medical Alert Labels

## 6000 Series

JETER® 9500/5300 Compatible  
3/4" H x 1-1/2" W (Poly laminated)

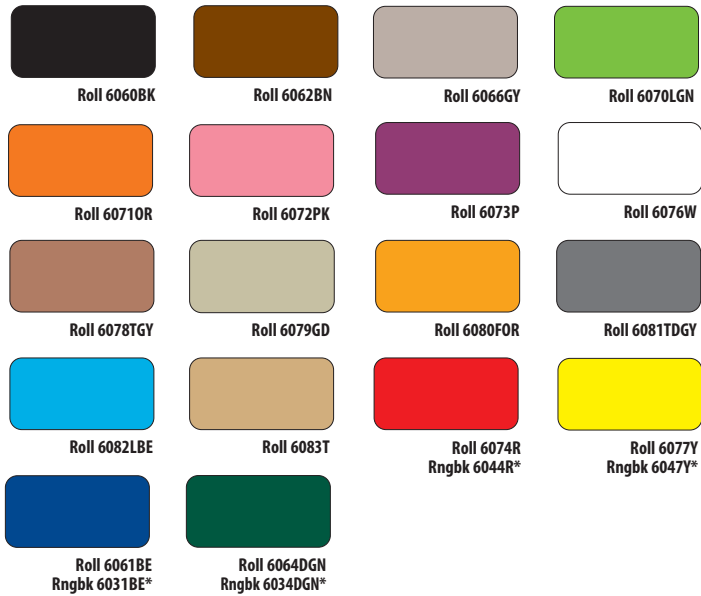

**ROLL (500 labels/roll)**  
Individual Colors  
(see label number) 500 labels  
**Complete Set 6089SET**  
18 rolls, 9,000 labels

**RINGBOOK (27 labels/sheet)**  
Individual Colors  
(see label number) 270 labels  
\*1 sheet each Blue, Red, Green & Yellow  
in Ringbook Starter Kit 1300 & 1500 Series

## 7300 Series

Control-O-Fax® Compatible  
3/4" H x 1-1/2" W (Vinyl)

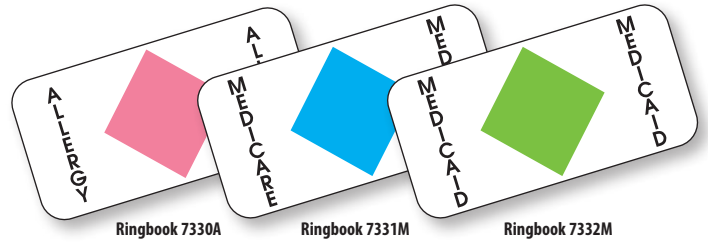

**RINGBOOK (27 labels/sheet)**  
Individual Label (see label number) 270 labels

## 7600 Series

JETER® 5800/7100 Compatible  
3/4" H x 1-1/2" W (Poly laminated)

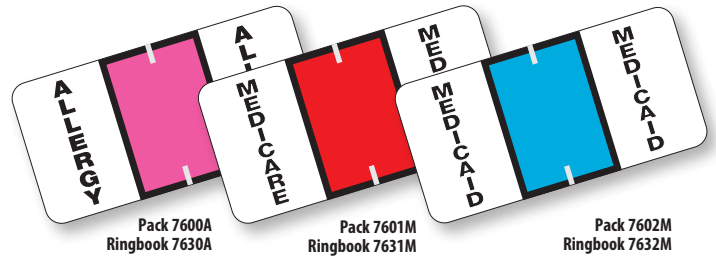

**PACK (12 labels/sheet)**  
Individual Label (see number) 240 labels  
**RINGBOOK (27 labels/sheet)**  
Individual Label (see number) 270 labels

## 6400/6500 Series

JETER® 6200/6300 Compatible  
3/8" H x 7/8" W (Matte)

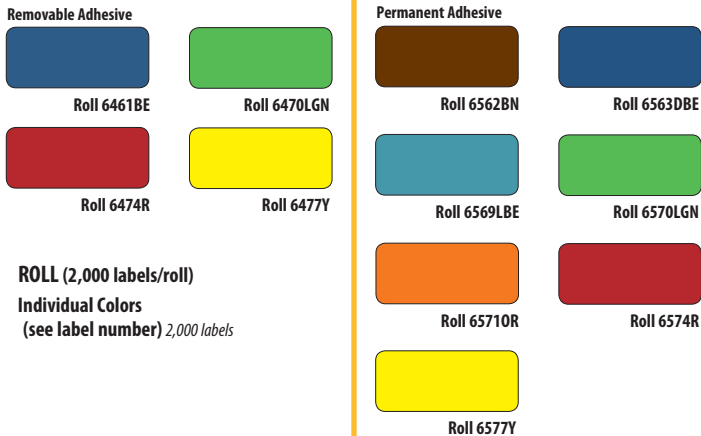

**ROLL (2,000 labels/roll)**  
Individual Colors  
(see label number) 2,000 labels

## 7700 Series

TABBIES® 54500 Compatible  
13/16" H x 1-9/16" W  
(100# Tag w/Poly)

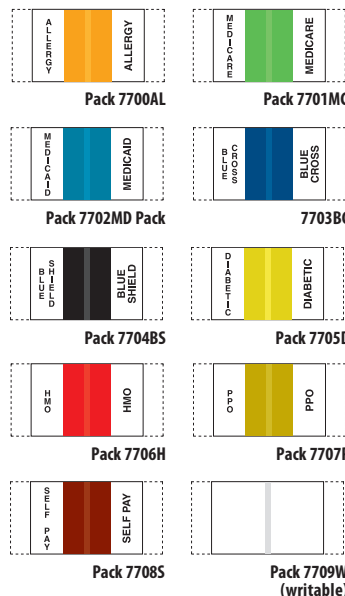

**PACK (12 labels/sheet)**  
Individual Label  
(see label number) 108 labels

# Name & Mylar Protector Labels

## 7000 Series

Pressure-Sensitive 3-1/2" W x 5/8" H LABELS

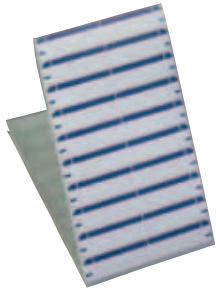

1-up 250 per box

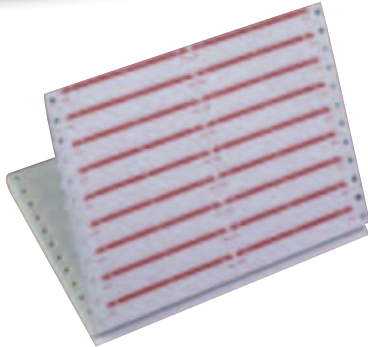

2-up 1,000 per box

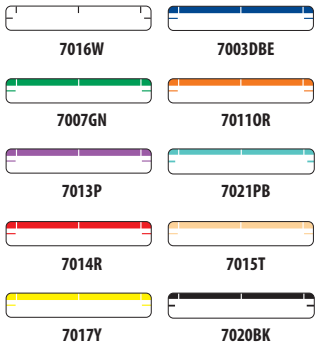

1-up typewriter or hand writable  
(see label number) 250 labels

2-up typewriter or dot matrix pin-feed  
(see label number) 1,000 labels

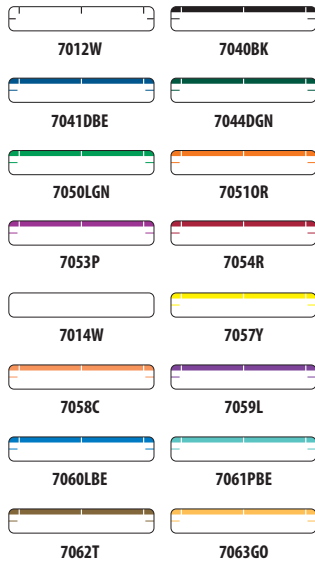

## Name Labels

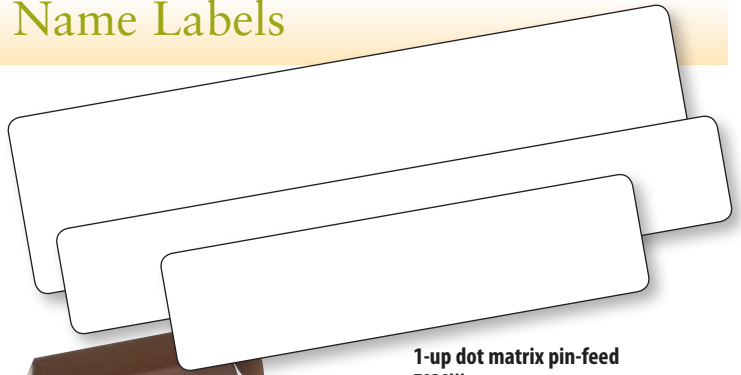

1-up dot matrix pin-feed

7020W 5,000 labels  
3-1/2" W x 9/16" H White

7025W 5,000 labels  
3-1/2" W x 15/16" H White  
(fits 4 lines of type)

2-up dot matrix pin-feed Mini Label

7030W 1,000 labels  
2-1/2" W x 5/8" H White  
For use with mini file folder/pocket.

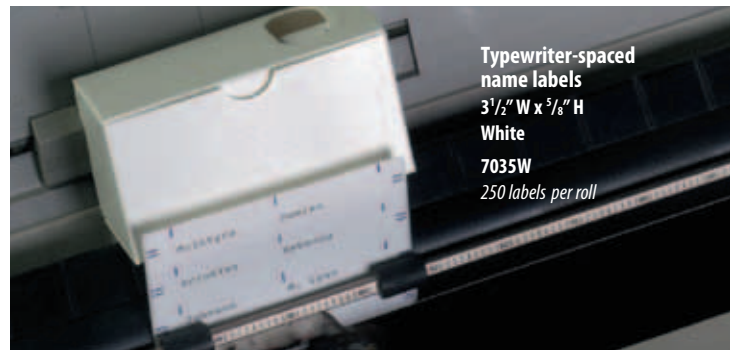

Typewriter-spaced name labels

3 1/2" W x 5/8" H  
White

7035W  
250 labels per roll



## LNL Series



LNL-54 Red



LNL-12 White



LNL-50 Green



LNL-41 Dk. Blue



LNL-62 Tan



LNL-53 Purple



LNL-60 Lt. Blue



2-up laser printer labels  
3-7/16" W x 9/16" H Color Bar or White

30 labels per sheet, 25 sheets per pack.  
Sheet size 8-1/2" X 11" 750 labels  
(see label number)

LNL-14 White/Blank 7,500 labels

# Name & Mylar Protector Labels

## 7500 Series Clear Label Protectors

3-1/2" length protects name label only and 8" length protects full tab.

Item	Stock No.	Qty	Description Dimensions before folding
A	7500TP	500	Clear 3-1/2" W x 1-3/4" H
B	7510TP	100	Clear 8" W x 1-3/4" H
B	7550TP/500	500	Clear 8" W x 1-3/4" H

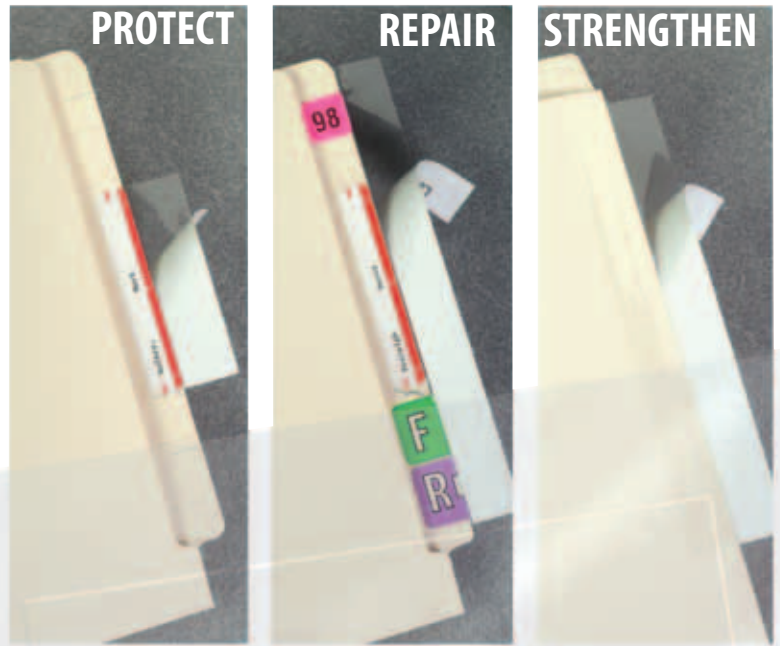

## Mylar Label Protectors

- Add durability
- Protect typed name labels from smudging
- Wraparound design
- Solid color or color stripe for additional color coding designation
- Repair worn chart tabs or spines

B

A

## FASTFIX™ Folder Reinforcer

- ◀ PROTECT
- ◀ REPAIR
- ◀ SEAL
- ◀ STRENGTHEN

Applied label is 2-1/2" H x 10-5/8" W

- 1 Dispense just 1" of a FASTFIX label.
- 2 Place exposed adhesive onto the center of the folder spine and hold down with one hand.
- 3 Without holding the box use your other hand to pull the release strip (white paper) straight back. The box will follow and dispense one FASTFIX label.
- 4 Press firmly to secure. (Based on condition of the folder a label roller may be required for good adhesion.)



- 7590TP  
CLEAR POLY
- 7590MTV  
MANILA TYVEK

## 7500 Series

3-1/2" W x 1-3/4" H before folding

- Blue 7501BE
- Green 7507GN
- Red 7514R
- Yellow 7517Y

Individually packaged 500 per color



## 7400 Series

3 1/2" W x 2" H before folding

- Clear 7400TP
- Blue 7401BE
- Green 7407GN
- Red 7414R
- Yellow 7417Y

Individually packaged 500 per color

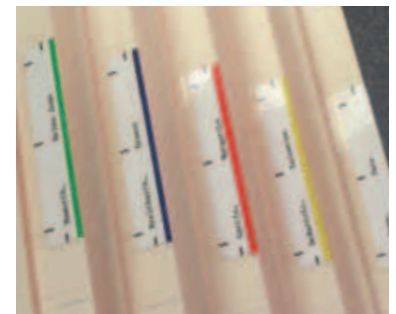



# Transcription Labels & Sheets

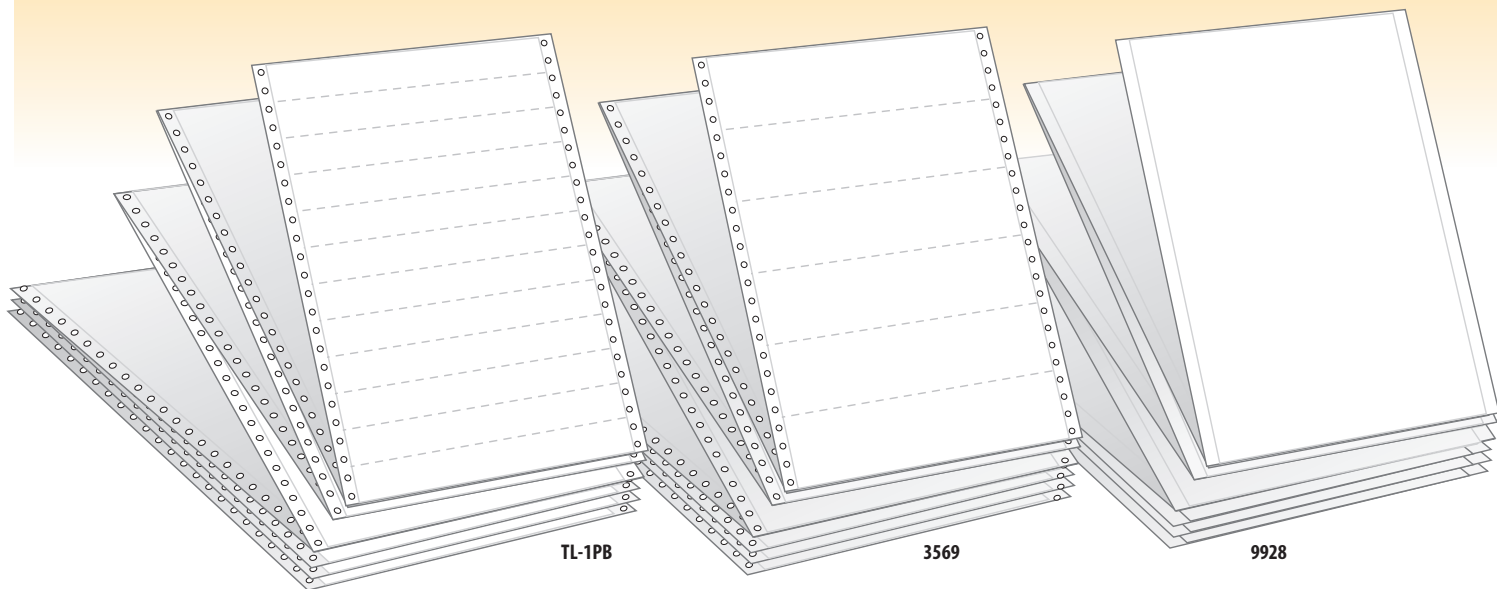

## Fan-Folded w/Pinfeeds (7-3/4" W label) 8-1/2" W x 12" H sheet

Style	Height	Color	Lbls/pkg
TL-1P	1"	White	2500
TL-2P	2"	White	1250
TL-4P	4"	White	625
TL-12P	12"	White	209

## Fan-Folded w/Pinfeeds (8" W label) 9" W x 12" H sheet

Style	Height	Color	Lbls/pkg
3525	1"	White	1000
3569	2"	White	1000
3574	4"	White	500
3582	12"	White	500

## Fan-Folded w/out Pinfeeds (8" W label) 8-1/2" W x 12" W sheet

Style	Height	Color	Lbls/pkg
TL-1	1"	White	2500
TL-2	2"	White	1250
3548	1"	White	1000
3549	2"	White	1000
9928	12"	White	500

## Laser Printer Sheets (8" W label) 8-1/2" W x 11" H sheet

Perforated Style			
Style	Height	Color	Lbls/pkg
3426	1"	White	1000
3427	2"	White	1000
3421	11"	White	100
LTL-11	11"	White	500

Quick-Peel Style			
Style	Height	Color	Lbls/pkg
27070	1"	White	1000
27071	2"	White	500
27072	3 1/2"	White	300

## Continuous Paper Roll (8" W label) 8-1/2" W x 4800" long

Style	Height	Color	Lbls/pkg
9934	Full Roll	White	400 ft.

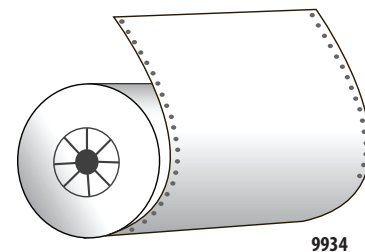

### Perforated Style



### Quick-Peel Style

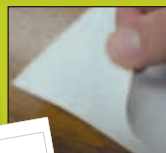

# Code A Print

## Code A Print

Codeaprint.com is a Web based label print utility that puts you in control of your label printing needs. With codeaprint.com, you're just 3 easy steps away from printing brilliant color-coded labels complete with individualized bar codes and graphics on-demand from your own laser or inkjet printer.

1. **Select a label design**
2. **Enter or import your data**
3. **Print your label**

### What You Need To Use Codeaprint.com

- Internet access
- Your account license
- Codeaprint.com label stock
- Your label data
- Custom designed label (if required)
- Your printer

For more information regarding codeaprint.com, please contact us or visit [www.codeaprint.com](http://www.codeaprint.com).



### 8" Folder Labels

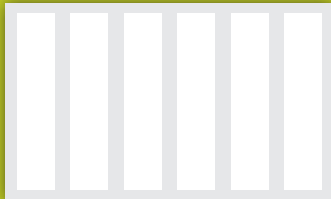

FS68L - Laser  
FS68WS - Ink Jet  
1-1/2" x 8"  
6 labels per sheet  
50 sheets per package

### 4" Filing Labels

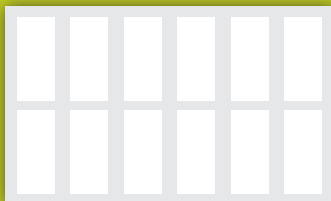

FS4L - Laser  
FS4WS - Ink Jet  
1-1/2" x 3-56.8/64"  
12 labels per sheet  
50 sheets per package

### Convert-A-Tab

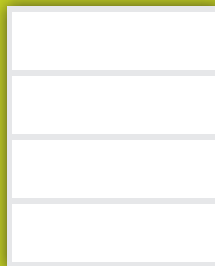

FSCVTL - Laser  
FSCVTW - Ink Jet  
8" x 2-5/8"  
4 labels per sheet  
50 sheets per package

### 7-11/16" Tab Match

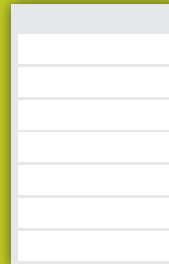

LZFS-78 - Laser  
IJFS-78 - Ink Jet  
7-11/16" x 1-11/16"  
7 labels per sheet  
350 labels total

### 8" Labels Smead Match

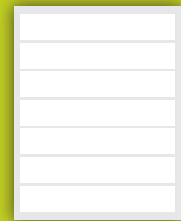

LZ7FS - Laser  
IJ7FS - Ink Jet  
8" x 1-7/16"  
7 labels per sheet  
350 labels total

# codeaprint.com

on-demand label printing

Refill labels for various Codeaprint.com label designs

# Allergy Warning Labels

**NO KNOWN ALLERGIES**

**NO KNOWN ALLERGIES**

MAP6480 FL. Blue 3" x 1" 250/Roll Code MN

**ALLERGIC TO PENICILLIN**

MAP507 FL. Red Code MB

**NO KNOWN ALLERGIES**

MAP506 LT. Blue Code MB

**ALLERGIES**

Drug \_\_\_\_\_

Food \_\_\_\_\_

Latex \_\_\_\_\_

Other \_\_\_\_\_

MAP3280 White/Blue 3-1/4" x 1-3/4" 250/Roll Code MM

**ALLERGIC TO:**

PENICILLIN

CODEINE

SULFA

\_\_\_\_\_

\_\_\_\_\_

\_\_\_\_\_

MAP5130 FL. Chartreuse 3-1/4" x 1-3/4" Code MM

**MEDICATION ALLERGY**

MAP5140 White/Red Code MM

**ALLERGIES**

\_\_\_\_\_

\_\_\_\_\_

\_\_\_\_\_

\_\_\_\_\_

MAP1630 FL. Red 3-1/4" x 1-3/4" 250/Roll Code JJ

 **ALLERGIES**

\_\_\_\_\_

\_\_\_\_\_

\_\_\_\_\_

MAP486 FL. Red 4" x 2-1/2" 100/Roll Code MJ

**ALLERGIES**

\_\_\_\_\_

\_\_\_\_\_

\_\_\_\_\_

\_\_\_\_\_

UL926 FL. Red 2-1/2" x 2-1/2" 390/Roll Code MC

**ALLERGIES/DRUG REACTIONS**

\_\_\_\_\_

\_\_\_\_\_

\_\_\_\_\_

NO KNOWN ALLERGIES

MAP1730 FL. Pink 3-1/4" x 1-3/4" 250/Roll Code JJ

 **ALLERGIES/DRUG REACTIONS**

\_\_\_\_\_

\_\_\_\_\_

NO KNOWN ALLERGIES

MAP327 FL. Red 4" x 2-1/2" 100/Roll Code MJ

**ALLERGIES/DRUG REACTIONS**

\_\_\_\_\_

\_\_\_\_\_

NO KNOWN ALLERGIES

MAP4870 FL. Red 2" x 2" 250/Roll Code MU

**ALLERGIC TO:**

PENICILLIN

CODEINE

SULFA

\_\_\_\_\_

\_\_\_\_\_

\_\_\_\_\_

MAP4900 FL. Red 3-1/4" x 1-3/4" 250/Roll Code MM

**ALLERGIC TO:**

PENICILLIN

CODEINE

SULFA

\_\_\_\_\_

\_\_\_\_\_

\_\_\_\_\_



MAP488 FL. Red 4" x 2-1/2" 100/Roll Code MJ

**ALLERGIC TO:**

PENICILLIN

CODEINE

SULFA

\_\_\_\_\_

\_\_\_\_\_

\_\_\_\_\_

MAP4890 FL. Red 2" x 2" 250/Roll Code MU

**ALLERGIES/DRUG REACTIONS**

\_\_\_\_\_

\_\_\_\_\_

NO KNOWN ALLERGIES

UL927 FL. Red 3-1/4" x 1-3/4" 250/Roll Code MM

**ALLERGIC:** \_\_\_\_\_

\_\_\_\_\_

UL927 White/Red 5-1/2" x 1" 175/Roll Code MD

**ALLERGIES**

LATEX  PENICILLIN

DYE  CODEINE

TAPE  SULFA

OTHER  ERYTHROMYCIN

NO KNOWN ALLERGIES

MAP3250 FL. Red 3-1/4" x 1-3/4" 250/Roll Code MM

# Allergy Warning Labels



MAP167 White/Red 6-1/2" x 1" 100/Roll Code MM

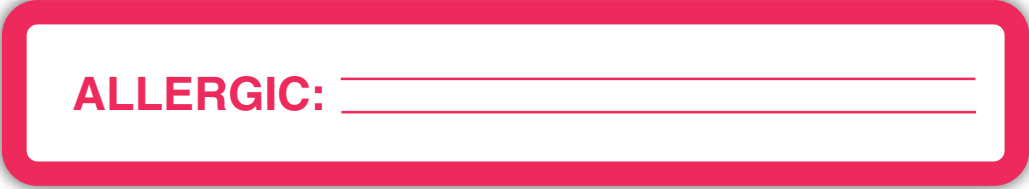

UL927 White/Red 5-1/2" x 1" 175/Roll Code MD



MAP6440 Red 3-1/4" x 1-3/4" 250/Roll Code MM



MAP3300 Red 3-1/4" x 1-3/4" 250/Roll Code MM



MAP3310 Red 3-1/4" x 1-3/4" 250/Roll Code MM



MAP6430 Red 3" x 1" 250/Roll Code MN

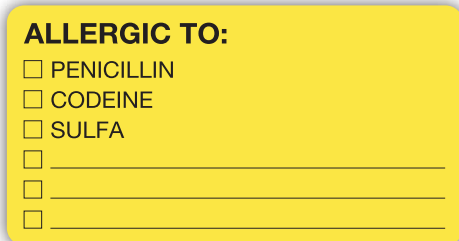

MAP1550 FL. Chartreuse 3-1/4" x 1-3/4" 250/Roll Code JJ

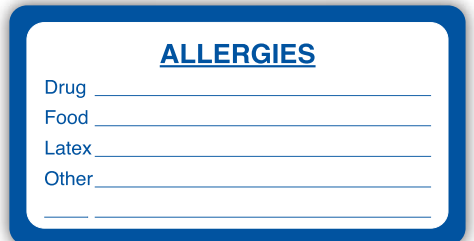

MAP3280 White/Blue 3-1/4" x 1-3/4" 250/Roll Code MM



MAP6110 Red 3" x 1" 250/Roll Code MN



MAP1000 Red 1-1/2" x 7/8" 250/Roll Code HH



MAP3330 Red 2" x 2" 250/Roll Code MU



MAP3340 Red 2" x 2" 250/Roll Code MU



MAP6270 Red 3" x 1" 250/Roll Code MN



MAP2240 Red 1-1/2" x 7/8" 250/Roll Code HH



MAP3290 Red 3" x 1" 250/Roll Code MN



MAP498 White/Red 2-1/2" x 3/4" 300/Roll Code ME

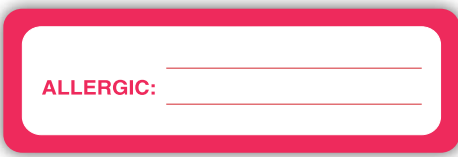

MAP3360 White/Red 3" x 1" 250/Roll Code MN



MAP3370 White/Blue 1-1/2" x 7/8" 250/Roll Code ML



UL702 White/Red 3" x 1-1/8" 320/Roll Code MC

# Allergy Warning Labels

**ALLERGIC TO:**

MAP4910 FL. Chartreuse  
1-1/2" x 7/8" 250/Roll  
Code ML

**ALLERGIC TO LATEX**

MAP6260 Red  
1-1/2" x 7/8" 250/Roll  
Code ML

**ALLERGIC TO PENICILLIN**

MAP3380 Red  
1-1/2" x 7/8" 250/Roll  
Code ML

**ALLERGIC TO:**

MAP496 FL. Orange 2-1/2" x 3/4"  
300/Roll Code ME

**NO KNOWN ALLERGIES**

MAP1510 LT. Blue  
1-1/2" x 7/8" 250/Roll  
Code HH

**ALLERGIC TO:**  
 CODEINE  
 SULFA  
 PENICILLIN

MAP4920 FL. Orange  
1-1/2" x 7/8" 250/Roll  
Code ML

**ALLERGY ALERT**

MAP4930 FL. Red  
1-1/2" x 7/8" 250/Roll  
Code ML

**ALLERGIC TO:**

MAP497 FL. Pink 2-1/2" x 3/4"  
300/Roll Code ME

**ALLERGIC TO:**

MAP3390 FL. Red  
1-1/2" x 7/8" 250/Roll  
Code ML

**ALLERGIC TO:**

MAP3350 FL. Pink  
1-1/2" x 7/8" 250/Roll  
Code ML

**ALLERGIC TO:**

MAP3320 FL. Orange  
1-1/2" x 7/8" 250/Roll  
Code ML

**ALLERGIC TO:**

MAP326 FL. Red 2-1/2" x 3/4"  
300/Roll Code ME

**ALLERGIC TO:**

MAP4950 FL. Pink 3" x 1" 250/Roll  
Code MN

**ALLERGIC TO:**

UL180 FL. Red 1-5/8" x 7/8" 500/Roll  
Code MD

**ALLERGIC TO: PENICILLIN**

MAP499 FL. Orange 2-1/2" x 3/4"  
300/Roll Code ME

**ALLERGIC TO:**

MAP4940 FL. Orange 3" x 1" 250/Roll  
Code MN

**ALLERGIC**

UL019 FL. Red 1-5/8" x 7/8" 500/Roll  
Code MD

**ALLERGIC TO:**

UL808 FL. Red 2-1/4" x 7/8"  
420/Roll Code MD

**ALLERGIC TO:**

MAP3240 FL. Red  
3" x 1" 250/Roll Code MN

**ALLERGIC TO:**

UL439 FL. Red 1-1/4" x 5/16"  
500/Roll Code MM

**NO KNOWN ALLERGIES**

UL810 White/Red 2-1/4" x 7/8"  
420/Roll Code MD

**ALLERGIC TO:**

SS16 FL. Red 1-7/8" x 3/4"  
500/Roll Code MH

**ALLERGIC TO:** .....

UL928 FL. Pink 4" x 1" 240/Roll Code MD

# Chart Labels

**Patient Record Confidential**

MAP252 Green 6-1/2" x 1" 100/Roll Code MK

**Patient Record Confidential**

MAP256 Green 4" x 2-1/2" 100/Roll Code MJ

**Patient Record Confidential**

MAP255 Green 2" x 2" 500/Roll Code MH

**CONFIDENTIAL**  
For Authorized Personnel Only

**CONFIDENTIAL**  
For Authorized Personnel Only

MAP253 Red 4" x 2-1/2" 100/Roll Code MJ

**CONFIDENTIAL**  
For Authorized Personnel Only

MAP254 Red 2" x 2" 500/Roll Code MH

The privacy and security of your personal health information is important to us!

MAP251 Red 6-1/2" x 1" 100/Roll Code MK

MAP6860 FL. Green 1-1/2" x 7/8" Code ML

**AUTHORIZATIONS ON FILE**

---

APPROVED BY \_\_\_\_\_

---

DATE \_\_\_\_\_

MAP6880 Red 3-1/4" x 1-3/4" Code MM

**Do Not Release PATIENT RECORD**

MAP687 Red 2-1/2" x 3/4" ME

**PRIVACY RESTRICTIONS:** \_\_\_\_\_

MAP712 Red 5-1/2" x 1" 100/Roll Code MM

**HIPAA Requirements**

<b>Privacy Notice:</b>	<b>By:</b>	<b>Date:</b>
<input type="checkbox"/> Given to patient	_____	_____
<input type="checkbox"/> Acknowledgement received	_____	_____
<b>Authorization/Other:</b>		
<input type="checkbox"/> Disclosure authorization on file	_____	_____
<input type="checkbox"/> Restriction Request on file	_____	_____
<input type="checkbox"/> Other	_____	_____

MAP7130 FL. Red 4" x 2" Code MM

**2010 Authorizations On File**

MAP670 FL. Green 1-1/4" x 5/16" Code MB

**HIPAA**

MAP720 FL. Red 1-1/4" x 5/16" Code MB

**Signed Acknowledgement of Notice of Privacy Practices on File**

MAP710 FL. Blue 2" x 1" Code MB

**2010 Authorization On File**

MAP7210 FL. Green 1-1/4" x 5/16" Code MB

**Do Not Destroy**  
Minor Patient  
Minor Patient  
**Do Not Destroy**

UL925 FL. Red 1-7/8" x 1-7/8" 500/Roll Code MD

**Do Not Destroy**  
Mammography  
Mammography  
**Do Not Destroy**

UL967 FL. Red 1-7/8" x 1-7/8" 500/Roll Code MD

**CONFIDENTIAL**

MAP2000 FL. Red 1-1/2" x 7/8" Code MB

**HIPAA**

MAP7190 FL. Red 1-1/2" x 7/8" Code MB

**ADVANCE DIRECTIVE ON FILE**

DATE \_\_\_\_\_

UL589 FL. Green 2-1/4" x 7/8" 420/Roll Code MD

**ADVANCE DIRECTIVE**

\_\_\_\_ Yes      \_\_\_\_ No

Signature \_\_\_\_\_ Date \_\_\_\_\_

UL588 FL. Green 2-1/4" x 7/8" 420/Roll Code MD

**ORIGINAL PLEASE RETURN**

UL806 FL. Green 2-1/4" x 7/8" 420/Roll Code MD

**X-RAY COPIES DO NOT RETURN**

UL807 FL. Yellow 2-1/4" x 7/8" 420/Roll Code MD

**DIABETIC**

DIABETIC

MAP3120 Red 3" x 1" 250/Roll Code MN

**DO NOT DESTROY DO NOT DESTROY**

UL1420 FL. Red 3" x 1" 250/Roll Code MN

**COUMADIN PATIENT**

COUMADIN PATIENT

MAP5220 FL. Chartreuse 3" x 1" 250/Roll Code MN

**NAME ALERT**

Two patients with same name

NAME ALERT

MAP6470 FL. Chartreuse 3" x 1" 250/Roll Code MN

**ATTENTION**

ATTENTION

MAP5200 Green 3-1/4" x 1-3/4" 250/Roll Code MM

**NAME ALERT**

**NAME ALERT**

**TWO PATIENTS WITH THE SAME NAME**

Date of Birth \_\_\_\_\_

MAP3180 Blue 3-1/4" x 1-3/4" 250/Roll Code MM

\_\_\_\_\_

\_\_\_\_\_

\_\_\_\_\_

MAP3130 Red 3-1/4" x 1-3/4" 250/Roll Code MM

**NAME ALERT**

Date of Birth \_\_\_\_\_

NAME ALERT

MAP3110 Blue 3" x 1" 250/Roll Code MN

**ATTENTION**

ATTENTION

\_\_\_\_\_

\_\_\_\_\_

\_\_\_\_\_

MAP3200 Red 3-1/4" x 1-3/4" 250/Roll Code MM

**NAME ALERT**

Date of Birth \_\_\_\_\_

MAP3170 Blue 3-1/4" x 1-3/4" 250/Roll Code MM

**NAME ALERT**

**TWO PATIENTS WITH THE SAME NAME**

Date of Birth \_\_\_\_\_

NAME ALERT

MAP3100 Blue 3-1/4" x 1-3/4" 250/Roll Code MM

**ATTENTION**

ATTENTION

\_\_\_\_\_

\_\_\_\_\_

\_\_\_\_\_

MAP3190 Red 2" x 2" 500/Roll Code MU

\_\_\_\_\_

\_\_\_\_\_

\_\_\_\_\_

\_\_\_\_\_

UL843 Yellow 2-1/4" x 2-3/8" 45/Pack Code MN

**MEDICAL ALERT**

UL188 FL. Red 1-5/8" x 7/8" 250/Roll Code MD

**AUTHORIZATION REQUIRED**

UL005 FL. Pink 1-5/8" x 7/8" 500/Roll Code MD

\_\_\_\_\_

\_\_\_\_\_

\_\_\_\_\_

MAP3210 Red 2" x 2" 500/Roll Code MU

\_\_\_\_\_

\_\_\_\_\_

\_\_\_\_\_

\_\_\_\_\_

UL849 FL. Pink 2-1/4" x 2-3/8" 45/Pack Code MN

**CANCELLED APPOINTMENT**

ON

UL158 FL. Green 1-5/8" x 7/8" 500/Roll Code MD

**ADVANCE DIRECTIVE**

Living Will \_\_\_\_\_

Health Care Proxy \_\_\_\_\_

Durable Power of Attorney for Health Care \_\_\_\_\_

Other \_\_\_\_\_

UL851 FL. Green 2-1/2" x 2-1/2" 390/Roll Code MF

\_\_\_\_\_

\_\_\_\_\_

\_\_\_\_\_

\_\_\_\_\_

UL844 White 2-1/4" x 2-3/8" 45/Pack Code MN

**PRIVACY RESTRICTIONS**

\_\_\_\_\_

\_\_\_\_\_

\_\_\_\_\_

\_\_\_\_\_

MAP711 FL. Red 2-1/2" x 2-1/2" Code MU

# Chart Labels

**NAME ALERT**  
Two patients with same name

MAP1050 FL. Chartreuse  
Code HH

**ATTENTION:**

MAP1010 Red  
Code HH

**MEDICAL ALERT:**

MAP1600 Red  
Code HH

**NOTE:**

MAP1660 Red  
Code HH

**NAME ALERT**  
Birthdate \_\_\_\_\_

MAP1180 FL. Red  
Code HH

**DIABETIC**

MAP2460 Red  
Code HH

**COUMADIN PATIENT**

MAP1590 FL. Chartreuse  
Code HH

**Rh NEGATIVE**

MAP1720 Red  
Code HH

**PNEUMOVAX**  
Date \_\_\_\_\_  
Initial \_\_\_\_\_

MAP1890 White  
Code HH

**ALLERGIC TO PENICILLIN**

MAP3380 Red  
Code ML

**LIVING WILL**

MAP2440 Red  
Code HH

**DNR**

MAP2010 FL. Orange  
Code HH

**ASTHMA**

MAP3520 FL. Pink  
Code ML

**DIABETIC**

MAP3530 FL. Pink  
Code ML

**PREGNANT**

MAP5010 FL. Pink  
Code ML

**MINOR**

MAP3550 FL. Green  
Code ML

**HYPERTENSION**

MAP5020 Red  
Code ML

**DECEASED**  
Date \_\_\_\_\_

MAP3560 LT. Blue  
Code ML

**PREMEDICATE**

MAP2490 Red  
Code HH

**TETANUS**  
Date \_\_\_\_\_  
Initial \_\_\_\_\_

MAP2430 FL. Pink  
Code HH

**COLLECTION AGENCY**  
DATE \_\_\_\_\_

MAP2180 FL. Chartreuse  
Code ML

**COLLECTION**

MAP1070 FL. Red  
Code HH

**ACCOUNT PLACED FOR COLLECTION**

MAP5050 FL. Red  
Code ML

**X-RAYS**  
Handle with Care

MAP2410 FL. Red  
Code HH

**SEE HEALTH HISTORY**

MAP2480 Red  
Code HH

**PREMEDICATE**

MAP7040 Blue  
Code ML

**ON ANTI-COAGULANTS**

MAP3580 FL. Orange  
Code ML

**Spanish**  
is preferred by the patient

MAP3540 LT. Blue  
Code ML

**FLU VACCINE**  
Date \_\_\_\_\_

MAP1900 FL. Green  
Code HH

**HEALTH HISTORY UPDATE**

MAP3570 FL. Green  
Code ML

**PREMEDICATE**

MAP344 FL. Pink  
Code MB

**HYPERTENSION**

MAP347 FL. Chartreuse  
Code MB

**MEDICAL ALERT**

MAP164 FL. Red  
Code MM

**STAT**

MAP343 FL. Red  
Code MB

**HEART CONDITION**

MAP187 FL. Red  
Code MM

**Rh NEGATIVE**

MAP511 FL. Pink  
Code MB

**DIABETIC**

MAP226 FL. Green  
Code MM

**COUMADIN PATIENT**

MAP228 FL. Chartreuse  
Code MB

**NAME ALERT**

MAP345 FL. Chartreuse  
Code MB

**HEPATITIS**

MAP610 FL. Green  
Code MB

**SMOKER**

MAP186 FL. Pink  
Code MB

**PACEMAKER**

MAP229 FL. Chartreuse  
Code MM

**ADVANCE DIRECTIVE**

MAP346 FL. Orange  
Code MB

**DECEASED**

MAP199 FL. Orange  
Code MM



## NAME ALERT

Date of Birth \_\_\_\_\_

\_\_\_\_\_

**Two Patients with Same Name**

MAP5150 White/Blue Code MM

## NAME ALERT

D.O.B. \_\_\_\_\_

MAP3410 FL. Chartreuse Code MM

## ADVANCE DIRECTIVE

Living Will \_\_\_\_\_

Health Care Proxy \_\_\_\_\_

Durable Power of Attorney  
for Health Care \_\_\_\_\_

Other \_\_\_\_\_

MAP3500 FL. Orange Code MM

### ALERTS

<input type="checkbox"/> DIABETIC	<input type="checkbox"/> NAME ALERT
<input type="checkbox"/> HEART CONDITION	<input type="checkbox"/> IMPLANTS
<input type="checkbox"/> ON ANTICOAGULANTS	<input type="checkbox"/> PREMEDICATE
<input type="checkbox"/> COUMADIN PATIENT	<input type="checkbox"/> HEARING IMPAIRED
<input type="checkbox"/> PACEMAKER	<input type="checkbox"/> ADVANCE DIRECTIVE
<input type="checkbox"/> NO EPINEPHRINE	<input type="checkbox"/> OTHER
<input type="checkbox"/> MITRAL VALVE PROLAPSE	

MAP3400 FL. Chartreuse Code MM

## DRUG SENSITIVITY

MAP5160 White/Red Code MM

### URINALYSIS

Date \_\_\_\_\_

Name \_\_\_\_\_ DOB \_\_\_\_\_

Glucose \_\_\_\_\_ pH \_\_\_\_\_

Bili \_\_\_\_\_ Protein \_\_\_\_\_

Ketone \_\_\_\_\_ Urobili \_\_\_\_\_

Sp. Gr. \_\_\_\_\_ Nitrate \_\_\_\_\_

Blood \_\_\_\_\_ Leuko \_\_\_\_\_

MAP3510 White Code MM

### CHART INACTIVATED

- Moved/Unable to Contact
- Transferred to Another Doctor
- Non-Payment
- Missed Appointments
- No Response To Scheduling Attempts
- Patient Deceased
- Other \_\_\_\_\_

MAP1540 White Code JJ

## MEDICATION ALLERGY

MAP5140 White/Red Code MM

## MEDICAL ALERT

MAP5180 FL. Red Code MM

### MEDICAL HISTORY UPDATE

MAP3600 FL. Chartreuse Code MM

### PATIENT INFORMED OF RESULTS

Date \_\_\_\_\_ By \_\_\_\_\_

Comments \_\_\_\_\_

\_\_\_\_\_

\_\_\_\_\_

MAP2360 FL. Pink Code MM

## MEDICAL ALERT

MAP3420 White/Red Code MM

Weight	BP	Temp	Pulse

MAP3590 FL. Chartreuse Code MN

MAP707

MAP500

### PRIMARY CARE PHYSICIAN:

Dr. \_\_\_\_\_

MAP2220 FL. Chartreuse Code MN

LABEL CODE INFORMATION		
Label Code	Size	Qty Per Roll
HH	1-1/2" x 7/8"	250
ML		
MB	1-1/4" x 5/16"	500
MM		
JJ	3-1/4" x 1-3/4"	250
MM		
MN	3" x 1"	250

# Spanish/English Collection Labels

## CUENTA SERIAMENTE ATRASADA

Envíe el pago completo para evitar que su cobro sea traspasado a una agencia de cobranzas.

## ACCOUNT SERIOUSLY OVERDUE

Remit payment in full to prevent collections.

MAP6980 FL. Red  
Code MU

## SU CUENTA ESTÁ VENCIDA.

¡Apreciaríamos que Ud. nos envíe su pago hoy mismo!

## YOUR ACCOUNT IS PAST DUE.

We would appreciate your payment today!

MAP6960 FL. Red  
Code MU

## SEGUNDO AVISO

Esta cuenta está vencida. Por favor, sírvase enviar un pago hoy mismo. Si ya ha enviado el pago, por favor haga caso omiso de este aviso.

## SECOND NOTICE

This account is past due. Please remit payment today. If payment has been made, please disregard this notice.

MAP7010 FL. Pink  
Code MU

## SALDO VENCIDO

Por favor, envíe un pago HOY MISMO!

## PAST DUE

Please remit TODAY!

MAP6890 FL. Red  
Code MU

## ÚLTIMO AVISO

Si no recibimos noticias suyas a más tardar en 10 días, esta cuenta será traspasada para su gestión por nuestra agencia de cobranzas.

## FINAL NOTICE

If we do not hear from you within 10 days, this account will be turned over to our collection agency.

MAP7020 FL. Red  
Code MU

## ÚLTIMO AVISO

Éste es el último estado de cuenta que se le enviará a Ud. A menos que Ud. envíe un pago inmediatamente, la cuenta será traspasada para que se gestione su cobro por una agencia de cobranzas.

## FINAL NOTICE

This is the last statement that will be sent to you. Unless paid at once the account will be turned over for collection.

MAP7000 FL. Red  
Code MU

**MUCHAS GRACIAS** por su reciente pago a cuenta. Nosotros confiamos en que Ud. continuará enviando estos pagos hasta que la cuenta esté totalmente pagada.

**THANK YOU** for your recent payment on your account. We trust you will continue these remittances until the account is paid in full.

MAP6900 FL. Pink  
Code MU

## VENCIDO

El pronto pago de este saldo atrasado hará que Ud. mantenga su buen crédito.

Sírvase enviar su pago hoy mismo.

## PAST DUE

Prompt payment of this balance due will preserve your good credit rating.

Mail your check today.

MAP6990 LT. Blue  
Code MU

**Simplemente un recordatorio amistoso** de que su cuenta está atrasada. Por favor, ¿nos podría enviar un pago?

**Just a friendly reminder** that your account is overdue. Won't you please mail your remittance?

MAP6950 FL. Green  
Code MU

**¡MUCHAS GRACIAS!**  
Apreciaremos que envíe pronto un pago.

**THANK YOU!**  
Your prompt payment is appreciated.

MAP6910 LT. Blue  
Code MU

SI UD. NO PUEDE PAGAR EL SALDO TOTAL,  
**POR FAVOR ENVÍE UN PAGO PARCIAL.**

IF YOU ARE UNABLE TO PAY IN FULL,  
**PLEASE SEND A PARTIAL PAYMENT.**

MAP6920 FL. Pink  
Code MU

ESTE SALDO PUEDE SER TRANSFERIDO A SU TARJETA



SIMPLEMENTE LLÁMENOS

THIS BALANCE MAY BE TRANSFERRED TO YOUR



JUST CALL US

MAP6970 FL. Chartreuse  
Code MU

SI UD. NO PUEDE PAGAR EL TOTAL DE LA CUENTA...  
**POR FAVOR MANDE UN PAGO A CUENTA.**

IF YOU ARE UNABLE TO PAY IN FULL...  
**PLEASE SEND A PARTIAL PAYMENT.**

MAP1940 Teal/Black  
Code MS

**ÚLTIMO AVISO**  
Éste es el último estado de cuenta que le será enviado. A menos que Ud. pague inmediatamente, su cuenta será pasada para su gestión por un cobrador.

**FINAL NOTICE**  
This is the last statement that will be sent to you. Unless paid at once, the account will be turned over for collection.

MAP6050 Purple/Black  
Code MS

**SU CUENTA ESTÁ VENCIDA**  
¡Apreciaríamos mucho recibir su pago hoy mismo!

**YOUR ACCOUNT IS PAST DUE**  
We would appreciate your payment today.

MAP6060 Purple/Black  
Code MS

Su compañía de seguros ya ha pagado la parte de la cuenta que le corresponde a ella.  
**ESTE ESTADO DE CUENTAS MUESTRA EL MONTO QUE UD. DEBE.**

Your insurance company has already paid its share of your bill.

**THIS STATEMENT IS FOR THE AMOUNT YOU OWE.**

MAP6070 Blue/Black  
Code MS

## ÚLTIMO AVISO

Si no recibimos su pago dentro de 10 días, su cuenta será pasada a nuestra agencia de cobranzas para su gestión.

## FINAL NOTICE

If we do not hear from you within 10 days, this account will be turned over to our collection agency.

MAP6080 Blue/Black  
Code MS

## ¿PODEMOS AYUDARLE?

Estamos dispuestos a hacer arreglos para que Ud. pueda hacer pagos regulares para cancelar este saldo. Por favor, sírvase llamarnos o visitarnos hoy mismo.

## MAY WE HELP YOU?

We are willing to make arrangements for regular payments to clear up this balance. Please call or stop in today.

MAP7030 FL. Pink  
Code MU

## POR FAVOR, TOME NOTA

Esta cuenta está **VENCIDA**. Solicitamos cortésmente su pronta atención a este asunto.

## PLEASE NOTE

This account is **PAST DUE**. Your prompt attention is courteously requested.

MAP6940 FL. Chartreuse  
Code MU

## ¡ESTE SALDO ESTÁ VENCIDO!

Su pago puntual evitará que iniciemos gestiones de cobranza.

## THIS BALANCE IS OVERDUE!

Prompt payment will avoid collection procedures.

MAP6930 FL. Red  
Code MU

# Insurance Chart Labels

**INSURANCE PROVIDER:**

\_\_\_\_\_

MAP1110 White/Red  
Code HH

ATTENTION OFFICE STAFF:  
**CO-PAY**  
\$ \_\_\_\_\_  
Collect at time of visit

MAP1310 FL. Red  
Code HH

**INSURANCE**  
\_\_\_\_\_  
\_\_\_\_\_  
\_\_\_\_\_

MAP1700 FL. Red  
Code HH

**INSURANCE**

MAP2840 FL. Red  
Code ML

**REFERRAL  
NEEDED**

MAP1170 FL. Pink  
Code HH

**MEDICARE**

MAP1160 FL. Orange  
Code HH

**MEDICARE**

MAP2910 FL. Orange  
Code ML

**CO-PAY**  
\_\_\_\_\_

MAP2890 FL. Orange  
Code ML

**INSURANCE**

MAP2880 FL. Red  
Code ML

**SELF PAY**

MAP1320 FL. Green  
Code HH

**MEDICAID**

MAP1340 FL. Pink  
Code HH

**MEDICAID**

MAP5240 FL. Pink  
Code ML

**HMO**  
\_\_\_\_\_

MAP1030 FL. Red  
Code HH

**WORKERS'  
COMP.**

MAP1690 FL. Green  
Code HH

INSURANCE YR. \_\_\_\_\_  
PRIMARY \_\_\_\_\_  
SECONDARY \_\_\_\_\_

MAP2850 FL. Chartreuse  
Code ML

**BC/BS**

MAP1650 LT. Blue  
Code HH

**MEDICARE  
HMO**

MAP5260 LT. Blue  
Code ML

**HMO**  
\_\_\_\_\_

MAP1620 FL. Chartreuse  
Code HH

**REFERRAL  
EXPIRES:**  
\_\_\_\_\_

MAP2330 FL. Orange  
Code HH

**MEDICARE  
AND  
INSURANCE**

MAP5280 FL. Chartreuse  
Code ML

**REFERRED BY:**  
  
Date \_\_\_\_\_

MAP5290 FL. Orange  
Code ML

**HMO**  
Must obtain  
prior authorization

MAP5300 FL. Orange  
Code ML

**WORKER'S COMP.**

MAP5310 FL. Green  
Code ML

**MANAGED  
CARE**

MAP5330 FL. Green  
Code ML

**REFERRING PHYSICIAN**

MAP5340 FL. Pink  
Code ML

**HMO/PPO**

MAP1040 FL. Red  
Code HH

**PPO**

MAP1330 FL. Red  
Code HH

**AUTO**

MAP5480 FL. Chartreuse  
Code ML

**MANAGED CARE**  
PRIOR APPROVAL  
REQUIRED  
CO-PAY \$ \_\_\_\_\_

MAP1300 FL. Pink  
Code HH

Medicare  BC/BS  
 Medicaid  HMO  
 Self Pay  PPO

MAP2380 FL. Chartreuse  
Code HH

**PRECERTIFICATION  
REQUIRED**

MAP5350 FL. Chartreuse  
Code ML

Insurance \_\_\_\_\_  
Lab \_\_\_\_\_  
Radiologist \_\_\_\_\_  
Co-Pay \_\_\_\_\_

MAP1100 FL. Green  
Code HH

**NO  
REFERRAL  
NEEDED**

MAP1840 FL. Green  
Code HH

**INSURANCE  
VERIFIED**  
Date \_\_\_\_\_  
Date \_\_\_\_\_  
Date \_\_\_\_\_

MAP2960 FL. Chartreuse  
Code ML

**PRIVATE**

MAP2970 FL. Green  
Code ML

**LABEL CODE INFORMATION**

Label Code	Size	Qty Per Roll
HH	1-1/2" x 7/8"	250
ML		
MS	1-1/2" x 1-1/2"	250
MU	2" x 2"	250

# Insurance Chart Labels

**UNITED HEALTHCARE**

MAP2320 FL. Pink Code HH

**HUMANA**

MAP2310 FL. Green Code HH

**AETNA**

MAP1750 FL. Red Code HH

**CIGNA**

MAP1430 FL. Chartreuse Code HH

**NO INSURANCE**

MAP2870 FL. Green Code ML

**BLUE CROSS**

MAP2900 LT. Blue Code ML

**MEDIGAP**

MAP2920 FL. Red Code ML

**PRIOR APPROVAL REQUIRED**

MAP5500 FL. Chartreuse Code ML

**PREAUTHORIZATION REQUIRED**

MAP5490 FL. Chartreuse Code ML

**PPO**

UL004 White 1-5/8" x 7/8" 500/Roll Code MD

**CO-PAY**

MAP122 FL. Red Code MM

**INSURANCE**

MAP119 FL. Red Code MM

**MEDICARE**

MAP113 FL. Orange Code MM

**BC/BS**

MAP127 LT. Blue Code MM

**HMO**

MAP191 FL. Red Code MM

**MEDICAID**

MAP120 FL. Pink Code MM

**BLUE CROSS**

MAP536 LT. Blue Code MB

**REFERRAL NEEDED**

MAP161 FL. Pink Code MM

**HMO**

UL006 White 1-5/8" x 7/8" 500/Roll Code MD

**WORKERS' COMP.**

MAP121 FL. Green Code MM

**BLUE SHIELD**

MAP537 LT. Blue Code MB

**PRIOR APPROVAL REQUIRED**

MAP129 FL. Pink Code MM

**SELF PAY**

MAP123 FL. Green Code MM

**CAPITATION**

MAP302 LT. Blue Code MB

**MEDIGAP**

MAP293 FL. Red Code MB

**MEDI-CAL**

MAP539 FL. Red Code MB

**SIGNATURE ON FILE**

MAP538 FL. Green Code MB

**INSURANCE**

UL007 FL. Chartreuse 1-5/8" x 7/8" 500/Roll Code MD

**PPO**

MAP112 FL. Green Code MM

**PRIVATE**

MAP542 FL. Green Code MB

**CASH ONLY**

MAP541 FL. Red Code MB

**HMO**  
Do you have authorization?

MAP540 FL. Orange Code MB

**SECONDARY INSURANCE**

MAP124 FL. Chartreuse Code MM

**AETNA**

MAP128 FL. Red Code MM

**CIGNA**

MAP546 FL. Chartreuse Code MB

**PRECERT # \_\_\_\_\_  
DATE \_\_\_\_\_**

MAP625 FL. Pink Code MB

**AUTO**

MAP126 FL. Chartreuse Code MM

**NO INSURANCE**

MAP286 FL. Green Code MB

**LABEL CODE INFORMATION**

Label Code	Size	Qty Per Roll
HH	1-1/2" x 7/8"	250
ML		
MB	1-1/4" x 5/16"	500
MM		
MM	3-1/4" x 1-3/4"	250
JJ		
MN	3" x 1"	250

Insurance \_\_\_\_\_  
 Co-Pay \_\_\_\_\_ Deductible \_\_\_\_\_  
 Referral needed \_\_\_\_\_ Double coverage \_\_\_\_\_  
 Prior Approval Required \_\_\_\_\_  
 Medicare \_\_\_\_\_ Medicare Supplement \_\_\_\_\_  
 Workers Comp \_\_\_\_\_ Personal Injury \_\_\_\_\_  
 No Insurance \_\_\_\_\_ Debt Risk \_\_\_\_\_

MAP2950 FL. Orange Code MM

Referral# \_\_\_\_\_  
 Expires \_\_\_\_\_ #Visits \_\_\_\_\_  
 Diagnosis \_\_\_\_\_

1	5	9	13	17
2	6	10	14	18
3	7	11	15	19
4	8	12	16	20

MAP2450 White Code JJ

**MANAGED CARE PLAN**

Patient Name \_\_\_\_\_  
 ID Number \_\_\_\_\_  
 Plan Name \_\_\_\_\_  
 Insurance Phone # \_\_\_\_\_  
 \_\_\_\_\_ Referral \_\_\_\_\_ Preauth. \_\_\_\_\_ Precert.  
 \_\_\_\_\_ Lab \_\_\_\_\_  
 \_\_\_\_\_ Hospital \_\_\_\_\_  
 \_\_\_\_\_ Other \_\_\_\_\_

MAP5510 White Code MM

**INSURANCE**

\_\_\_\_\_  
 \_\_\_\_\_  
 \_\_\_\_\_  
 \_\_\_\_\_

MAP1570 FL. Red Code JJ

**INSURANCE**

\_\_\_\_\_  
 \_\_\_\_\_

MAP2830 FL. Pink Code MM

Medicare  Worker Comp.  
 Medicaid  Self Pay  
 BC/BS  Auto  
 United Healthcare  Kaiser  
 Aetna  CIGNA  
 Other \_\_\_\_\_

MAP2940 FL. Chartreuse Code MM

# Insurance Chart Labels / Collection Labels

**CO-PAY** ATTENTION OFFICE STAFF:  
**CO-PAY**  
\$ \_\_\_\_\_  
Collect at time of visit

MAP3150 Blue 3-1/4" x 1-3/4"  
250/Roll Code MM

ATTENTION OFFICE STAFF:  
**CO-PAY**  
\$ \_\_\_\_\_  
Collect at time of visit

MAP6410 FL. Red 3-1/4" x 1-3/4"  
250/Roll Code MM

**CO-PAY** ATTENTION OFFICE STAFF:  
**CO-PAY**  
\$ \_\_\_\_\_  
Collect at time of visit

MAP3160 Blue 3" x 1"  
250/Roll Code MM

**INSURANCE PROVIDER**  
INSURANCE PROVIDER

MAP5190 Blue 3-1/4" x 1-3/4"  
250/Roll Code MM

**INSURANCE**  
INSURANCE

MAP5210 FL. Pink 3-1/4" x 1-3/4"  
250/Roll Code MM

**INSURANCE**  
INSURANCE

MAP6420 FL. Pink 3" x 1"  
250/Roll Code MN

**MEDICARE**  
MEDICARE

MAP3080 FL. Orange 3" x 1"  
250/Roll Code MN

**INSURANCE**  
INSURANCE

MAP3140 FL. Orange 3" x 1"  
250/Roll Code MN

**MEDICAID**  
MEDICAID

MAP3090 FL. Pink 3" x 1"  
250/Roll Code MN

ATTENTION OFFICE STAFF:  
**CO-PAY**  
\$ \_\_\_\_\_  
Collect at time of visit

MAP6460 FL. Red 3" x 1"  
250/Roll Code MN

**HMO**  
HMO

MAP6450 FL. Red 3" x 1"  
250/Roll Code MN

If Payment is Not Received  
By \_\_\_\_\_ Account  
Will Be Forwarded For  
Collection

UL529 FL. Green 2-1/4" x 7/8" 420/Roll  
Code MD

**PAST DUE** ←  
Prompt payment of this balance due  
will preserve your good credit rating.  
MAIL YOUR CHECK TODAY.

UL1401 FL. Green 3" x 7/8" 320/Roll Code MD

**YOUR INSURANCE COMPANY**  
has paid its share of your bill. This  
statement is for the amount payable  
directly by you. *Please Remit*

UL1423 FL. Red 3" x 7/8" 320/Roll Code MD

**REJECTED**  
BY YOUR INSURANCE COMPANY  
Your insurance company has rejected  
your claim for benefits; therefore this  
must be paid directly by you. Your  
prompt payment will be appreciated.

UL543 FL. Green 2-1/4" x 7/8" 420/Roll  
Code MD

Our records still show that you have not  
cleared your overdue account. If payment  
is not possible now, please let us hear  
from you so that we won't have to take  
further action.

UL1400 FL. Chartreuse 3" x 7/8" 320/Roll Code MD

**FINAL NOTICE**  
This is the last statement that will be sent to  
you. Unless paid at once the account will be  
turned over for collection.

UL1402 FL. Orange 3" x 7/8" 320/Roll Code MD

**WE HATE TO KEEP  
HOUNDING YOU,  
BUT YOUR BILL  
IS PAST DUE.**

UL520 FL. Pink 2-1/4" x 7/8" 420/Roll  
Code MD

**MEDICARE**  
has paid its share of your bill.  
This statement is for the amount  
payable directly by you to us.  
*Thank You!*

UL1412 FL. Pink 3" x 7/8" 320/Roll Code MD

**FINAL NOTICE**  
Much as we regret it we will be compelled to  
place this account in outside hands unless  
payment or arrangements are received  
**AT ONCE!**

UL1404 FL. Red 3" x 7/8" 320/Roll Code MD

Your **INSURANCE** has paid  
its share of your bill. This  
statement is for the amount  
payable directly by you to us.

UL539 FL. Orange 2-1/4" x 7/8" 420/Roll  
Code MD

# Collection - Billing/Reminder Labels

## FINAL NOTICE!

If we do not hear from you within 10 days, this account will be turned over to our collection agency.

MAP5890 Purple/Black Code MS

## Designer Collection and Insurance Labels

### LABEL CODE INFORMATION

Label Code	Size	Qty Per Roll
MS	1-1/2" x 1-1/2"	250

### LABEL CODE INFORMATION

Label Code	Size	Qty Per Roll
HH	1-1/2" x 7/8"	250
ML		

◀ Shown actual size: 1-1/2" x 1-1/2"

**YOUR INSURANCE COMPANY HAS PAID ITS SHARE OF YOUR BILL.**

This statement is for the amount payable directly by you.

MAP6720 Teal/Black Code MS

Your insurance covered all but the amount shown on this statement.

MAY WE PLEASE HAVE YOUR REMITTANCE BY RETURN MAIL?

MAP6730 Blue/Black Code MS

**PLEASE HELP**

Your insurance company has not paid. Please call and encourage them to pay today. It is your responsibility to see that they pay on time.

MAP5900 Teal/Black Code MS

Your Insurance Co. has not paid this claim because:

- Deductible Taken
- Noncovered Service
- Insurance Cancelled
- Requested Information Not Received

PLEASE REMIT PAYMENT IN FULL.

MAP5930 Orange/Black Code MS

Your insurance company has already paid its share of your bill.

**THIS STATEMENT IS FOR THE AMOUNT YOU OWE**

MAP5910 Orange/Black Code MS

**SECOND NOTICE**

This account is past due. Please remit payment today. If payment has been made, please disregard this notice.

MAP5960 Blue/Black Code MS

IF YOU ARE UNABLE TO PAY IN FULL . . .

**PLEASE SEND A PARTIAL PAYMENT**

MAP5950 Purple/Black Code MS

**THIS BALANCE IS OVERDUE!**

Prompt payment will avoid collection procedures.

MAP5970 Orange/Black Code MS

WE ARRANGED A PAYMENT PLAN THAT YOU AGREED TO.

Please Honor Your Arrangement and Pay Now. Thank You.

MAP5990 Blue/Black Code MS

**JUST A FRIENDLY REMINDER . . .**

that your account is overdue. Won't you please mail your remittance?

MAP5980 Purple/Black Code MS

**ACCOUNT SERIOUSLY OVERDUE**

Remit payment in full to prevent collections.

MAP6030 Purple/Black Code MS

**PLEASE NOTE**

This account is PAST DUE. Your prompt attention is courteously requested.

MAP6010 Teal/Black Code MS

**SECOND NOTICE**

Have you overlooked our first statement? Please remit the payment or contact our office to make arrangements.

MAP6020 Orange/Black Code MS

**MAY WE HELP YOU?**

We are willing to make arrangements for regular payments to clear up this balance. Please call or stop in today.

MAP6040 Blue/Black Code MS

**YOUR ACCOUNT IS PAST DUE!**

We would appreciate your payment today!

MAP6740 Orange/Black Code MS

**YOUR BALANCE DUE TO:**

- Your deductible
- Non-Covered Services
- Co-Pay

MAP6750 Orange/Black Code MS

**No Appointments can be made until the balance shown on this statement is paid.**

MAP6760 Purple/Black Code MS

Your insurance coverage is an agreement between you and your insurer.

It is your responsibility to remit payment for charges not covered by your plan.

MAP6780 Teal/Black Code MS

**FINAL NOTICE!**

This is the last statement that will be sent to you. Unless paid at once the account will be turned over for collection.

MAP5920 Purple/Black Code MS

**PAST DUE**

Please remit today!

MAP5940 Teal/Black Code MS

# Collection - Billing/Reminder Labels

## PAST DUE

Please remit TODAY!

MAP1350 FL. Red  
Code HH

## Just a friendly reminder

that your account is overdue. Won't you please mail your remittance?

MAP4220 FL. Green  
Code ML

IF YOU ARE UNABLE TO PAY IN FULL

PLEASE SEND A PARTIAL PAYMENT

MAP2020 FL. Pink  
Code HH

## PAST DUE

We accept VISA and MasterCard.  
Call our office with your card number.

MAP4570 FL. Orange  
Code ML

## ACCOUNT SERIOUSLY OVERDUE

Remit payment in full to prevent collections

MAP1400 FL. Red  
Code HH

## THIS BALANCE IS OVERDUE!

Prompt payment will avoid collection procedures.

MAP4490 FL. Red  
Code ML

## YOUR ACCOUNT IS PAST DUE.

We would appreciate your payment today!

MAP4480 FL. Red  
Code ML

THANK YOU for your recent payment on your account. We trust you will continue these remittances until the account is paid in full.

MAP4210 FL. Pink  
Code ML

## FINAL NOTICE

Your payment must be received within 10 days or immediate action will be taken.

MAP2130 FL. Red  
Code HH

## PLEASE...

Tell us if there is any reason why payment has not been sent to us.  
**THANK YOU.**

MAP5660 FL. Chartreuse  
Code ML

## PAST DUE

Prompt payment of this balance due will preserve your good credit rating.  
*Mail your check today.*

MAP4590 LT. Blue  
Code ML

## WE MISSED YOUR MONTHLY PAYMENT

Won't you please send it in now?

MAP4320 FL. Chartreuse  
Code ML

THIS BALANCE MAY BE TRANSFERRED TO YOUR

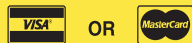

JUST CALL US

MAP4630 FL. Chartreuse  
Code ML

We arranged a payment plan that you agreed to. Please honor your arrangement and pay now. Thank you.

MAP4600 FL. Orange  
Code ML

## MAY WE HELP YOU?

We are willing to make arrangements for regular payments to clear up this balance. Please call or stop in today.

MAP4290 FL. Pink  
Code ML

## SECOND NOTICE

This account is past due. Please remit payment today. If payment has been made, please disregard this notice.

MAP2170 FL. Pink  
Code HH

## PLEASE REMIT TODAY

This account is small but we have many such accounts. Prompt payment would be sincerely appreciated.

MAP4560 FL. Chartreuse  
Code ML

## FINAL NOTICE

This is the last statement that will be sent to you. Unless paid at once the account will be turned over for collection.

MAP1360 FL. Red  
Code ML

*Regular payments must be made every month in order to maintain good credit.*

MAP4260 FL. Pink  
Code ML

## FINAL NOTICE

Your payment must be received within 10 days or your account will be reported to the CREDIT BUREAU.

MAP5690 FL. Red  
Code ML

## FRIENDLY REMINDER

This account is past due. Your prompt attention is courteously requested.

MAP4250 FL. Orange  
Code ML

## THANK YOU!

Your prompt payment is appreciated

MAP4240 LT. Blue  
Code ML

*Thank You!*

MAP4300 FL. Chartreuse  
Code ML

## SECOND NOTICE

Please remit payment in full TODAY

MAP4610 FL. Pink  
Code ML

## FINAL NOTICE!

MAP4770 FL. Red  
Code ML

## PAST DUE

Please contact us at once regarding your overdue account.

MAP5700 FL. Pink  
Code ML

## FINAL NOTICE

If we do not hear from you within 10 days, this account will be turned over to our collection agency.

MAP2030 FL. Red  
Code HH

## FINAL NOTICE

Sufficient time has been extended to you to make arrangements for payment of this past due account.  
**REMIT IN FULL TODAY**

MAP5710 FL. Red  
Code ML

## PLEASE REMIT

All accounts are due 30 days from date of service.

MAP5720 FL. Green  
Code ML

## PLEASE...

Having to ask a good patient for payment is not a pleasant task; however, your remittance would be greatly appreciated.

MAP4280 FL. Pink  
Code ML

*THANK YOU* for your previous payment. Reducing the balance on a regular weekly or monthly basis will be greatly appreciated.

MAP4270 FL. Orange  
Code ML

## PLEASE NOTE

This account is PAST DUE.  
*Your prompt attention is courteously requested.*

MAP4500 FL. Chartreuse  
Code ML

## CO-PAY OVERDUE

Co-pays are to be paid on the day of service.  
**PLEASE REMIT PROMPTLY**

MAP1370 FL. Pink  
Code HH

## PLEASE PAY IN FULL

Sending many statements for small balances is not cost effective.

MAP5770 FL. Green  
Code ML

## FINAL NOTICE

This is the last statement that will be sent to you. Unless paid at once your account will be referred to the credit bureau and collection service.

MAP4760 FL. Red  
Code ML

We sincerely appreciate the way you **CONSISTENTLY** pay your account.  
**YOU'RE JUST TERRIFIC!**

MAP4330 LT. Blue  
Code ML

**YOUR ACCOUNT HAS BEEN TURNED OVER TO OUR COLLECTION AGENCY. THERE IS NO NEED TO CONTACT US ANY FURTHER.**

MAP1410 FL. Red  
Code ML

*A partial payment on this past due account will be very much appreciated, if you are unable to pay in full today.*

MAP5780 FL. Orange  
Code ML

*In the future please be prepared to pay at the time of service.  
Thank you.*

MAP3960 FL. Pink  
Code ML

**PLEASE GIVE THIS ACCOUNT YOUR IMMEDIATE ATTENTION**  
It is long past due and settlement must be made without further delay.

MAP4340 FL. Red  
Code ML

# Collection - Billing/Reminder Labels

**ACCOUNT OVERDUE!**  
Please remit payment in full or call for a payment plan.

MAP1380 FL. Pink  
Code HH

**NO APPOINTMENTS CAN BE MADE** until the balance shown on this statement is paid.

MAP4690 FL. Orange  
Code ML

*Have you overlooked this statement?*  
Your prompt payment is appreciated!

MAP4310 FL. Chartreuse  
Code ML

Please call this office to make arrangements to clear up this account.

MAP2160 FL. Orange  
Code HH

**PLEASE BE AWARE THAT:**  
Failure to pay this outstanding balance may result in action being taken which could harm your credit rating.

MAP4520 FL. Red  
Code ML

**Payment is due at the time of service**

MAP4700 FL. Red  
Code ML

This is the amount due now. There may be other charges pending for which you will be billed at a later date.

MAP4720 FL. Green  
Code ML

We accept **MASTERCARD, VISA AND DISCOVER.**  
Call our office with your card number and we'll be happy to bill your account.

MAP5730 FL. Orange  
Code ML

**AMOUNT DUE**  
\$ \_\_\_\_\_

MAP4710 FL. Chartreuse  
Code ML

**SECOND NOTICE**  
This account is past due. Please remit payment today. If payment has been made, please disregard this notice.

MAP5680 FL. Pink  
Code ML

**SECOND NOTICE**  
Have you overlooked our first statement? Please remit the payment or contact our office to make arrangements.

MAP4540 FL. Orange  
Code ML

Your account has been set up on a payment plan. Please pay plan amount of \$ \_\_\_\_\_.  
*Thank You.*

MAP4400 FL. Green  
Code ML

**DO NOT PAY**  
Balance pending from your insurance.

MAP4410 LT. Blue  
Code ML

An installment plan can be set up to help pay your bill.  
**PLEASE CALL OUR CREDIT OFFICE AND ARRANGE A PAYMENT WITHOUT DELAY.**

MAP4350 LT. Blue  
Code ML

We've received no payment from you since \_\_\_\_\_.  
**PLEASE SEND PAYMENT TODAY TO SAFEGUARD YOUR CREDIT.**

MAP5740 FL. Red  
Code ML

**CO-PAY PLEASE PAY IN FULL**

MAP4420 LT. Blue  
Code ML



**WE ACCEPT VISA AND MASTERCARD.**  
Call our office with your card number and we'll be happy to bill your account.

MAP5760 FL. Orange  
Code ML

**CO-PAY OVERDUE**  
Co-pays are to be paid on the day of service.  
**PLEASE REMIT PROMPTLY.**

MAP1370 FL. Pink  
Code ML

Thank you for your recent payment.  
MAP436 FL. Pink  
Code MB

To pay with your credit card please complete:  
 Acct. No. \_\_\_\_\_  
 Exp. Date \_\_\_\_\_  VISA  MasterCard  
 Signature \_\_\_\_\_

MAP4680 FL. Chartreuse  
Code MN

**FRIENDLY REMINDER**  
Please check your records. We have not received your payment and a check would be appreciated.

MAP4440 FL. Pink  
Code MN

**SECOND NOTICE**  
This account is past due. Please remit payment today. If payment has been made, please disregard this notice.

MAP4450 FL. Pink  
Code MN

**FINAL NOTICE**  
Your payment must be received within 10 days  
**OR IMMEDIATE ACTION WILL BE TAKEN.**

MAP4460 FL. Red  
Code MN

**YOUR INSURANCE COMPANY HAS PAID ITS SHARE OF YOUR BILL.**  
This statement is for the amount payable directly by you.

MAP4470 FL. Orange  
Code MN

**WE ACCEPT MAJOR CREDIT CARDS**  
To pay with your credit card please complete:  
Acct. No. \_\_\_\_\_  
VISA \_\_\_\_\_ MasterCard \_\_\_\_\_ American Ex \_\_\_\_\_ Discover \_\_\_\_\_  
Exp. Date \_\_\_\_\_ Signature \_\_\_\_\_

MAP5790 FL. Chartreuse  
Code MN

**THIS BALANCE IS OVERDUE!**  
Prompt payment will avoid collection procedures.

MAP5820 FL. Green  
Code MN

**FINAL NOTICE**  
This is the last statement that will be sent to you. Unless paid at once, this account will be reported to the CREDIT BUREAU.

MAP5810 FL. Orange  
Code MN

**IF YOU ARE UNABLE TO PAY IN FULL...**  
PLEASE SEND PARTIAL PAYMENT

MAP5800 FL. Green  
Code MN





# Collection - Billing Labels

## Credit Card Labels

Keep clients informed about payment options and watch your accounts receivables improve.

**THIS BALANCE MAY BE TRANSFERRED TO YOUR**

 OR 

**JUST CALL US**

MAP4630 FL. Chartreuse Code ML

This balance may be transferred to your

Just call us!

MAP4650 FL. Orange Code ML

**We Accept VISA, MasterCard and American Express.**

Call our office with your card number and we'll be happy to bill your account.

MAP4660 FL. Orange Code ML

We accept VISA and MasterCard. If you wish to pay your account with your credit card, please complete the following lines:





Acct. No. \_\_\_\_\_

Exp. Date \_\_\_\_\_  VISA  MasterCard

Signature \_\_\_\_\_

MAP2500 FL. Chartreuse Code JJ

For your convenience, you may transfer this balance to your credit card account. To pay with your credit card, please complete the information below:



      

Acct. No. \_\_\_\_\_ Exp. Date \_\_\_\_\_

Amount \_\_\_\_\_ Signature \_\_\_\_\_

MAP2350 FL. Orange Code JJ

**To pay with your credit card please complete:**



Acct. No. \_\_\_\_\_

Exp. Date \_\_\_\_\_  VISA  MC  AmEx

Signature \_\_\_\_\_

MAP4670 FL. Orange Code MN

**To pay with your credit card please complete:**

Acct. No. \_\_\_\_\_

Exp. Date \_\_\_\_\_  VISA  MasterCard

Signature \_\_\_\_\_

MAP4680 FL. Chartreuse Code MN

We will accept VISA, MasterCard and Discover. If you wish to pay your account with your credit card, please complete the following:

VISA  MasterCard  Discover

Acct. No.

Exp. Date     Amt.

Signature \_\_\_\_\_

MAP4620 FL. Chartreuse Code MN

We accept VISA, MasterCard and American Express. If you wish to pay your account with your credit card, please complete the following:

Acct. No. \_\_\_\_\_

Exp. Date \_\_\_\_\_  VISA  MC  AmEx

Signature \_\_\_\_\_

MAP4640 FL. Orange Code MM

Your account is long past due. To avoid collection procedures, please complete one of the following in the next 10 days:

- Send full payment of your bill
- Call to set up a payment schedule
- Transfer the balance to your credit card

VISA  MasterCard  American Express  Discover

Acct. No. \_\_\_\_\_ Exp. Date \_\_\_\_\_

Signature \_\_\_\_\_

MAP2340 FL. Chartreuse Code JJ

LABEL CODE INFORMATION		
Label Code	Size	Qty Per Roll
HH	1-1/2" x 7/8"	250
ML		
MN	3" x 1"	250
MB	1-1/4" x 5/16"	500
MM	3-1/4" x 1-3/4"	250
JJ		

MC – Special size labels come in different quantities.

INSURANCE ACCOUNT INFORMATION	
PATIENT NAME (if dependent)	RELATION TO EMPLOYEE <input type="checkbox"/> SELF <input type="checkbox"/> SPOUSE <input type="checkbox"/> CHILD <input type="checkbox"/> OTHER
EMPLOYEE NAME	
SOCIAL SECURITY NUMBER OF EMPLOYEE	BIRTHDATE
EMPLOYER	UNION NO.
GROUP PLAN NAME	GROUP NO.
PRIMARY CARRIER NAME	POLICY NO.
SECONDARY CARRIER NAME	POLICY NO.

UL826 White 4" x 2-5/8" 240/Roll Code MC

**BAD DEBT**

MAP1080 FL. Red Code HH

**COLLECTION AGENCY**

DATE \_\_\_\_\_

MAP2180 FL. Chartreuse Code HH

**COLLECTION**

MAP1070 FL. Red Code HH

**ACCOUNT PLACED FOR COLLECTION**

MAP3040 FL. Red Code ML

**MISSED APPOINTMENT**

ON \_\_\_\_\_

MAP2370 FL. Pink Code HH

**COLLECTION AGENCY**

Date \_\_\_\_\_

MAP305 FL. Chartreuse Code MB

**COLLECTION SUMMARY**

Amount \_\_\_\_\_

Date final notice sent \_\_\_\_\_

Date placed in collection \_\_\_\_\_

Date placed with agency \_\_\_\_\_

Comments \_\_\_\_\_

Approved by \_\_\_\_\_

UL825 FL. Red 3" x 2" 320/Roll Code MC

# Collection - Billing Labels

Shown actual size: 3 1/4" x 1 3/4"

## FINAL NOTICE

This is the last statement that will be sent to you. Unless paid at once the account will be turned over for collection.

## Jumbo Collection Labels

Keep the lines of communication open with clients. These attention-getting labels can help prompt clients to take the appropriate steps regarding their account.

### FINAL NOTICE

This is the last statement that will be sent to you. Unless paid at once the account will be turned over for collection.

MAP4740 FL. Red Code MM

### FINAL NOTICE

If we do not hear from you within 10 days, this account will be turned over to our collection agency.

MAP4790 FL. Red Code MM

### FINAL NOTICE

If we do not receive your payment by \_\_\_\_\_ we will be forced to turn your account over for collection.

MAP1580 FL. Red Code JJ

### URGENT NOTICE!

Previous bills have been sent to you for the above charges. The balance is seriously past due. Immediate payment must be made. If we do not hear from you within 15 days, we will assume you purposely ignored this notice and we will send this account for further collection procedures.

MAP4780 FL. Red Code MM

### PLEASE CONTACT OUR OFFICE REGARDING YOUR OVERDUE BALANCE.

We'd like to work with you to develop a reasonable payment plan and help you keep your account in good standing. Thank you for your cooperation in this matter.

*We look forward to hearing from you.*

MAP4800 FL. Chartreuse Code MM

### COMMUNICATION IS IMPORTANT

We haven't received payment on your account, and we haven't heard from you regarding this balance.

#### PLEASE REMIT TODAY

Or further action will be necessary!

MAP4810 FL. Orange Code MM

### FINAL NOTICE

This is the last statement that will be sent to you. Unless paid at once your account will be referred to the credit bureau and collection service.

MAP4820 FL. Red Code MM

Dear Patient,  
Our "Pay-At-The-Desk" Policy helps avoid the high costs of billing, thus keeping your visits less costly. Please help us by being prepared to pay at the time of your visit in the future. Thank You.

MAP5850 FL. Chartreuse Code MM

### FINAL NOTICE

- This is the last statement that will be sent to you.
- Remit payment in full TODAY!
- We accept VISA & MASTERCARD.

MAP4830 FL. Red Code MM

### CAUTION:

Your account is now 90 days PAST DUE.

**Pay now and avoid collection action.**

MAP4840 FL. Red Code MM

### ATTENTION:

Your account is now 60 days PAST DUE.

**Please send all back payments today.**

MAP4850 FL. Pink Code MM

### FINAL NOTICE

Every courtesy has been extended regarding payment of this long overdue account.

Unless it is paid immediately your account will be turned over for collection.

MAP5840 FL. Red Code MM

### THIS BALANCE IS OVERDUE

Prompt payment will avoid collection procedures

You owe \$ \_\_\_\_\_

MAP5860 FL. Chartreuse Code MM

### NOTICE:

Your account is 30 days PAST DUE.

**Please send your payment today.**

MAP5870 FL. Green Code MM

#### LABEL CODE INFORMATION

Label Code	Size	Qty Per Roll
HH	1-1/2" x 7/8"	250
ML		
MB	1-1/4" x 5/16"	500
JJ	3-1/4" x 1-3/4"	250
MM		
MN	3" x 1"	250

MC - Special size labels come in different quantities.

# Collection - Insurance/Patient Responsibility

**YOUR INSURANCE COMPANY HAS PAID ITS SHARE OF YOUR BILL.**  
This statement is for the amount payable directly by you.

**MAP3690** FL. Red Code ML

In order to process your claim **YOUR INSURANCE COMPANY NEEDS INFORMATION**  
Please contact them or send us payment in full immediately

**MAP2100** FL. Green Code HH

This amount is your co-pay.  
Please pay at time of service in the future.

**MAP2050** FL. Orange Code HH

**PLEASE HELP**  
Your insurance company has not paid. Please call and encourage them to pay today. It is your responsibility to see that they pay on time.

**MAP2060** FL. Green Code HH

**YOUR INSURANCE COMPANY HAS ALREADY PAID ITS SHARE OF YOUR BILL.**  
This statement is for the amount you owe.

**MAP2200** FL. Orange Code HH

Your Insurance Co. has not paid this claim because:  
 Deductible Taken  
 Noncovered Service  
 Insurance Cancelled  
 Requested Information Not Received  
*Please remit payment in full.*

**MAP2120** FL. Chartreuse Code HH

**PATIENT RESPONSIBILITY DUE TO:**  
 Deductible  
 Noncovered Services  
 Co-Payment  
**PLEASE REMIT \$ \_\_\_\_\_ AS SOON AS POSSIBLE.**  
THANK YOU

**MAP3990** FL. Chartreuse Code ML

Your insurance company states this balance is your responsibility.  
Please remit today!

**MAP2080** FL. Chartreuse Code HH

**NO PAYMENT HAS BEEN RECEIVED FROM THE INSURANCE CLAIM WE FILED FOR YOU.**  
**This amount is now due and payable by you.**

**MAP2070** FL. Pink Code HH

Your primary and secondary insurances have paid their share of your bill. This statement is for the amount you owe.

**MAP2150** FL. Pink Code HH

**PLEASE...**  
let us know if you have insurance coverage for these services. If not, the balance shown is now due.

**MAP3710** FL. Green Code ML

**YOUR BALANCE DUE TO:**  
 Your Deductible  
 Non-Covered Services  
 Co-Pay  
\$ \_\_\_\_\_

**MAP3720** FL. Chartreuse Code ML

This statement is for your information. **YOUR INSURANCE CLAIM HAS BEEN BILLED.**

**MAP3730** LT. Blue Code ML

**INSURANCE PENDING**  
\$ \_\_\_\_\_  
**AMOUNT DUE NOW**  
\$ \_\_\_\_\_

**MAP3750** FL. Orange Code ML

Medicare has paid its share of your bill. This statement is for the amount payable directly by you to us.  
**Please remit.**

**MAP2090** FL. Red Code HH

Your insurance covered all but the amount shown on this statement. May we please have your remittance by return mail.

**MAP3770** FL. Green Code ML

Your insurance company has paid its share of your bill. You are responsible for deductibles and non-covered items on your assigned claim.

**MAP3780** FL. Orange Code ML

If you are covered by any insurance program including Medicare or Medicaid please inform our office immediately.

**MAP3790** FL. Pink Code ML

Should we be billing your insurance for all or part of this balance? If so, please call our office.

**MAP3840** LT. Blue Code ML

**ALL INSURANCE CLAIMS HAVE BEEN PAID**

**MAP3890** LT. Blue Code ML

Medicare has applied these charges toward your annual deductible.  
**PLEASE REMIT PAYMENT**

**MAP3910** FL. Chartreuse Code ML

**Statement reflects amount not covered by your insurance. Please pay in full.**

**MAP3850** FL. Red Code ML

**INSURANCE CLAIM REJECTED**  
Your claim for benefits has been rejected by your Insurance Company. This amount is now due and payable by you. Your prompt remittance will be appreciated.

**MAP3900** FL. Red Code ML

Although we are waiting for your insurance to pay, it will not cover your balance in full. A personal payment on your account will be appreciated.

**MAP3860** FL. Pink Code ML

**Medicare Pending**  
\$ \_\_\_\_\_  
**Amount Due By You**  
\$ \_\_\_\_\_

**MAP3920** FL. Orange Code ML

**YOUR CO-PAYMENT WAS NOT PAID BEFORE YOU LEFT OUR OFFICE.** In accordance with state and federal laws, you owe  
**PLEASE REMIT NOW.**

**MAP3950** FL. Orange Code ML

Medicare has paid its share of your bill. We would appreciate payment from you for the amount shown on this statement.

**MAP3870** FL. Green Code ML

**OUR RECORDS SHOW THAT YOU DO NOT HAVE INSURANCE.**  
If there are any changes please contact the office.

**MAP5640** LT. Blue Code ML

**YOUR BALANCE AFTER INSURANCE RESPONSE IS**  
\$ \_\_\_\_\_  
Thank you for prompt payment.

**MAP1020** LT. Blue Code HH

**THIS BALANCE IS YOUR INSURANCE CO-PAY. PLEASE PAY IN FULL.**

**MAP2140** FL. Pink Code HH

Your insurance company denied this claim because you did not respond to their request for further information.  
**THIS BILL IS YOUR RESPONSIBILITY.**

**MAP4010** FL. Red Code ML

All insurance claims have been paid. Your remaining balance is overdue.  
**PLEASE PAY PROMPTLY TO AVOID COLLECTION PROCEDURES.**

**MAP4050** FL. Pink Code ML

Your Insurance Company has sent **YOU** payment of its share of this bill . . . **YOUR ACCOUNT IS NOW DUE AND PAYABLE.**

**MAP4100** FL. Orange Code ML

Your insurance has been billed for you. **YOUR SHARE OF THIS BALANCE IS**  
\$ \_\_\_\_\_

**MAP3810** FL. Chartreuse Code ML

Your insurance company has applied these charges to your deductible. **THANK YOU FOR YOUR PROMPT PAYMENT.**

**MAP4020** FL. Pink Code ML

**PARTIAL BILLING**  
Additional Charges  
Pending Insurance.

**MAP4120** LT. Blue Code ML

Your insurance has been billed and charges applied to deductible.  
**PLEASE REMIT BALANCE**

**MAP4070** FL. Green Code ML

**Insurance payment OVERDUE**  
Please check with your carrier

**MAP4090** FL. Orange Code ML

**THESE SERVICES ARE NOT COVERED BY YOUR INSURANCE**

**MAP4110** FL. Green Code ML

Your insurance requires that co-payment be paid at time of service.

**MAP4130** FL. Green Code ML

**YOUR INSURANCE COVERAGE HAS BEEN TERMINATED.**  
Please pay in full or call to set up a payment schedule.

**MAP4150** FL. Orange Code ML

**YOUR INSURANCE COMPANY HAS APPLIED THESE CHARGES TO YOUR DEDUCTIBLE**

**MAP4160** FL. Chartreuse Code ML

PRICE CODE INFORMATION		
Label Code	Size	Qty Per Roll
HH	1-1/2" x 7/8"	250
ML		
Item Code	Size	Qty Per Roll
JJ	3-1/4" x 1-3/4"	250
MM		

# Collection - Insurance/Patient Responsibility

Your Insurance Company has advised us that you are responsible for a portion of your charges because of:

- Deductible
- Co-Payments
- \_\_\_\_\_

Dates for this charge: \_\_\_\_\_

Please remit payment IN FULL.

Balance Due:

MAP5570 FL. Orange Code MM

**We Have Not Been Paid On This Claim Because Your Insurance Company:**

- Sent payment to you
- Applied these charges to your deductible
- Does not cover this service
- Has not yet received the information requested from you
- Terminated your coverage on \_\_\_\_\_
- Other \_\_\_\_\_

Please remit in full or call to arrange a payment schedule.

MAP1560 FL. Chartreuse Code JJ

Your balance after Medicare paid is due to:

- Your deductible (\$100 yearly)
- Non-covered services
- 20% co-payment

You owe \$ \_\_\_\_\_

Thank You!

MAP4190 FL. Chartreuse Code MM

**Your Insurance Co. has not paid this claim because:**

- Deductible Taken
- Non-Covered Service
- Insurance Cancelled
- Requested Information Not Received

**Please remit payment in full.**

MAP5580 FL. Chartreuse Code MM

**PATIENT RESPONSIBILITY DUE TO:**

- Deductible
- Non-Covered Services
- Too Many Services in Time Period
- Maximum Benefit Allowed Reached
- Co-Payment

PLEASE REMIT \$ \_\_\_\_\_ AS SOON AS POSSIBLE

MAP4180 FL. Red Code MM

Insurance \_\_\_\_\_

PCP \_\_\_\_\_

I.D. # \_\_\_\_\_ Eff. Date \_\_\_\_\_

Co-Pay \_\_\_\_\_ Deductible \_\_\_\_\_

[ ] Referral Needed

MAP5600 FL. Green Code MM

**FINAL NOTICE**

- Your insurance has paid its share.
- If we do not hear from you within \_\_\_\_\_ days, this account will be turned over to the collection agency.
- REMIT IN FULL TODAY!

MAP5630 FL. Red Code MM

**REMINDER**

- Your insurance has paid its share.
- This is the amount that you owe.
- Please remit TODAY!

MAP5620 FL. Green Code MM

**PAST DUE**

- Your insurance has paid its share.
- Don't jeopardize your credit.
- Please remit TODAY!

MAP4170 FL. Chartreuse Code MM

**PLEASE PROCESS THIS CLAIM AS:**

- Rebill
- Corrections have been made
- First claim not received
- Secondary ins., EOB attached
- Claim filed, no response received

MAP2800 FL. Red Code MM

**RESUBMISSION**

This is not a duplicate billing. This claim has either been denied or never received. Please consider for benefits or instruct if patient owes.

MAP2610 FL. Chartreuse Code MM

**ATTENTION**

Please note authorization number: # \_\_\_\_\_

**AND PROCESS PROMPTLY!**

MAP6230 FL. Chartreuse Code MM

**YOUR INSURANCE COMPANY** has paid its share of your bill.

This statement is for the amount payable directly by you.

MAP4200 FL. Pink Code MM

LABEL CODE INFORMATION		
Label Code	Size	Qty Per Roll
HH	1 1/2" x 7/8"	250
ML	3 1/4" x 1 3/4"	250
MM	1 1/2" x 1 1/2"	250
MS	2" x 2"	250
MU	2" x 2"	250

# Insurance Carrier Collection Labels

This is not a duplicate claim.  
**Claim is unpaid**  
Please Process!

MAP1440 FL. Green  
Code HH

**DOCUMENTATION ATTACHED**  
**DO NOT SEPARATE FROM CLAIM**

MAP2650 FL. Green  
Code ML

**PRIMARY EOB ATTACHED**

MAP1480 FL. Green  
Code HH

Primary EOB Attached  
 Medicare EOB Attached

MAP7050 FL. Orange  
Code ML

Corrective Claim  
 Resubmitted Claim

MAP7060 FL. Chartreuse  
Code ML

Unless this claim is paid or denied within 30 days of this date, we will file a formal written **COMPLAINT** with the INSURANCE COMMISSIONER  
Date: \_\_\_\_\_

MAP2640 FL. Red  
Code ML

Submitting for secondary coverage.  
**SEE ATTACHED PLEASE**

MAP2660 FL. Pink  
Code ML

**RESUBMISSION:**  
This is not a duplicate billing. This claim has either been denied or never received. Please consider for benefits.

MAP2670 FL. Pink  
Code ML

**MEDICARE EOB ATTACHED**

MAP2690 FL. Orange  
Code ML

**INSURANCE:**  
This office has not received an explanation, payment or denial on this claim. We respectfully request one. Thank you.

MAP2700 FL. Orange  
Code ML

**CORRECTIVE CLAIM**

MAP1460 FL. Pink  
Code HH

–SECOND SUBMISSION–  
ORIGINAL CLAIM WAS SENT  
ON: \_\_\_\_\_

MAP1450 FL. Chartreuse  
Code HH

**RESUBMISSION:**  
This is not a duplicate billing. This claim has either been denied or never received. Please consider for benefits or instruct if patient owes.

MAP2680 FL. Chartreuse  
Code ML

**DOCUMENTATION ATTACHED**

MAP2720 FL. Pink  
Code ML

**BE ADVISED...**  
We report untimely payments to the Insurance Commissioner

MAP2750 FL. Chartreuse  
Code ML

**RESUBMITTED CLAIM**

MAP1470 FL. Green  
Code HH

**CLAIM PAYMENT ERROR**  
Please review for adjustment

MAP2740 FL. Orange  
Code ML

Our original claim was never paid or denied. Please process this bill for payment within 15 days or we will file a complaint with the Insurance Commissioner.

MAP1150 FL. Red  
Code HH

**TRACER PREVIOUSLY SUBMITTED CLAIM**

MAP2760 FL. Red  
Code ML

**MEDICAL RECORDS ATTACHED**  
Please do not separate from claim. Request for additional copies will be billed at a \$25 minimum charge.

MAP2730 FL. Chartreuse  
Code ML

**SECOND CLAIM SUBMISSION**  
Please Process Promptly

MAP2710 FL. Pink  
Code ML

**Documentation to support medical necessity is attached**

MAP2780 FL. Orange  
Code ML

Insurance Claim Resubmittal  
**SECOND REQUEST**  
Date: \_\_\_\_\_

MAP6160 FL. Green  
Code ML

**PLEASE SEND BENEFITS DIRECTLY TO INSURED**

MAP6170 FL. Red  
Code ML

Unless this claim is paid or denied within 45 days of this date, we will file a formal written **COMPLAINT** with the INSURANCE COMMISSIONER.  
Date: \_\_\_\_\_

MAP2770 FL. Red  
Code ML

**PLEASE PAY PROVIDER**  
Insured signature on file

MAP6150 FL. Orange  
Code ML

This is not a duplicate claim.  
**Claim is unpaid**  
**PLEASE PROCESS!**

MAP2570 Purple/Black  
Code MS

**RESUBMISSION**  
This is not a duplicate billing. This claim has either been denied or never received. Please consider for benefits.

MAP1970 Blue/Black  
Code MS

**PRIMARY EOB ATTACHED**  
**PLEASE PROCESS!**

MAP2600 Purple/Black  
Code MS

**DOCUMENTATION ATTACHED**  
**DO NOT SEPARATE FROM CLAIM**

MAP2580 Blue/Black  
Code MS

Submitting for secondary coverage.  
**SEE ATTACHED PLEASE**

MAP6180 Teal/Black  
Code MS

Unless this claim is paid or denied within 30 days of this date we will file a formal written complaint with the Insurance Commissioner.  
Date: \_\_\_\_\_

MAP6210 Orange/Black  
Code MS

**SECOND SUBMISSION ORIGINAL CLAIM WAS SENT ON:**  
\_\_\_\_\_

MAP6220 Orange/Black  
Code MS

# Solid Color Labels

## Blank Neon Laser Labels\*

Print your own message on these labels using your laser printer. Customize the message on each label. Available in sheets. 8-1/2" W x 11" H (100 sheets/pkg.)

Design your own color-coding system using these paper or vinyl labels. Choose from a large selection of colors and sizes. Vinyl labels are water-resistant and are designed for long-lasting durability.

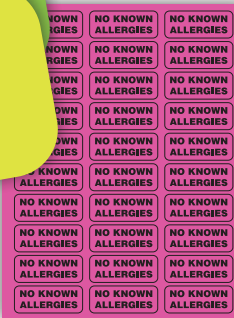
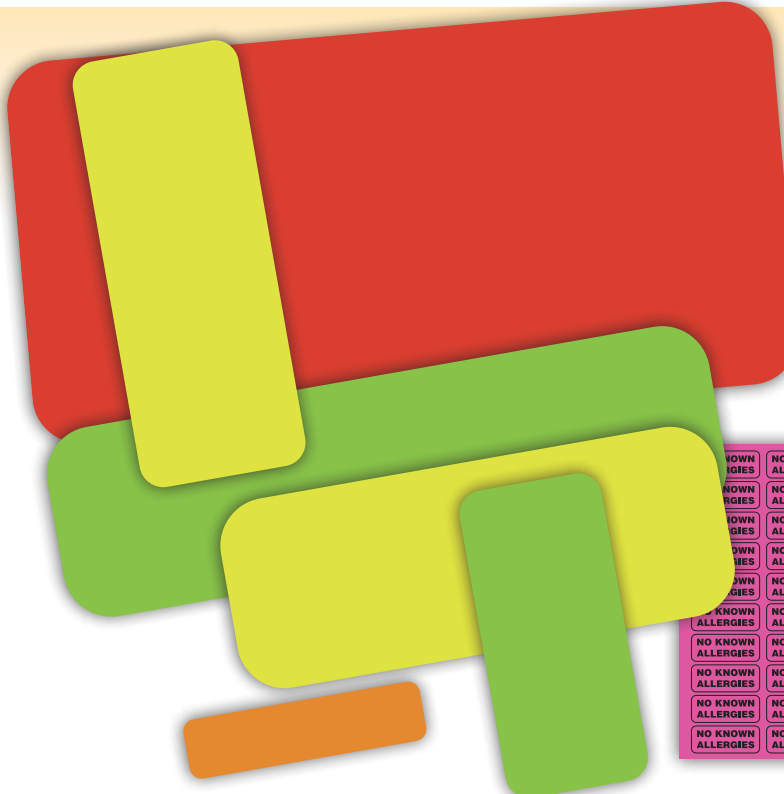

Blank Neon Laser Labels	3-1/2" X 1"	2-5/8" X 1"	4" X 2"
	20 Labels/Sheet	30 Labels/Sheet	10 Labels/Sheet
Color	Product #		
White	27836	27842	27848
Fl. Red	27837	27843	27849
Fl. Orange	27838	27844	27850
Fl. Yellow	27839	27845	27851
Fl. Green	27840	27846	27852
Fl. Pink	27841	27847	27853

Paper Rectangular Labels	1-1/4" X 5/16"	7/8" X 1-5/8"	7/8" X 2-1/4"	1-1/4" X 5/16"	7/8" X 2-1/4"
	500/Roll	500/Roll	500/Roll	240/Pack	90/Pack
Color	Product #				
Fl. Orange	UL446	UL160	UL554	UL347	UL571
Fl. Pink	UL447	UL161	UL555	UL348	UL572
Fl. Red	UL448	UL162	UL556	UL349	UL573
Fl. Green	UL449	UL163	UL557	UL350	UL574
Fl. Yellow	UL450	UL164	UL558	UL351	UL575
Blue	UL451	UL165	UL559	UL352	UL576
Yellow	UL452	UL166	UL560	UL353	UL577
White	UL453	UL167	UL561	UL354	UL578
Black	UL454	UL168	UL562	UL355	UL579
Lt. Green	UL458	UL172	UL566	UL359	UL583
Red	UL459	UL173	UL567	UL360	UL584
Dk. Blue	UL460	UL174	UL568	UL361	UL585
Lavender	UL461	UL175	UL569	UL362	UL586

Vinyl Rectangular Labels	7/8" X 1/4"	7/8" X 3/8"	3/4" X 7/8"
	500/Roll	500/Roll	500/Roll
Color	Product #		
Red	UL1500	UL1600	UL1700
Green	UL1501	UL1601	UL1701
Lt. Green	UL1502	UL1602	UL1702
Blue	UL1503	UL1603	UL1703
Orange	UL1505	UL1605	UL1705
Yellow	UL1506	UL1606	UL1706
Black	UL1507	UL1607	UL1707
Kelly Green	UL1511	UL1611	UL1711
Water Blue	UL1513	UL1613	UL1713
White	UL1514	UL1614	UL1714
Purple	UL1516	UL1616	UL1716

Paper Circular Labels	1/2" Dia.	3/4" Dia.	1" Dia.	1/2" Dia.	1" Dia.
	1000/Roll	1000/Roll	1000/Roll	360/Pack	150/Pack
Color	Product #				
Fl. Orange	UL1800	UL1900	UL2000	UL1817	UL2017
Fl. Pink	UL1801	UL1901	UL2001	UL1818	UL2018
Fl. Red	UL1802	UL1902	UL2002	UL1819	UL2019
Fl. Green	UL1803	UL1903	UL2003	UL1820	UL2020
Fl. Yellow	UL1804	UL1904	UL2004	UL1821	UL2021
Blue	UL1805	UL1905	UL2005	UL1822	UL2022
White	UL1807	UL1907	UL2007	UL1824	UL2024
Black	UL1808	UL1908	UL2008	UL1825	UL2025
Tan	UL1810	UL1910	UL2010	UL1827	UL2027
Lt. Green	UL1812	UL1912	UL2012	UL1829	UL2029
Red	UL1813	UL1913	UL2013	UL1830	UL2030
Dk. Blue	UL1814	UL1914	UL2014	UL1831	UL2031
Lavender	UL1815	UL1915	UL2015	UL1832	UL2032

Vinyl Circular Labels	1/4" Dia.	1/2" Dia.	3/4" Dia.
	1000/Roll	1000/Roll	1000/Roll
Color	Product #		
Red	UL2100	UL2200	UL2300
Green	UL2101	UL2201	UL2301
Lt. Green	UL2102	UL2202	UL2302
Blue	UL2103	UL2203	UL2303
Orange	UL2105	UL2205	UL2305
Yellow	UL2106	UL2206	UL2306
Black	UL2107	UL2207	UL2307
Pink	UL2110	UL2210	UL2310
Kelly Green	UL2111	UL2211	UL2311
Water Blue	UL2113	UL2213	UL2313
White	UL2114	UL2214	UL2314
Purple	UL2116	UL2216	UL2316

## PREASSEMBLED MEDICAL SYSTEM MAKES YOUR PRACTICE MORE EFFICIENT!

### The Complete Medical System

New preassembled medical charting system, you'll never have to spend staff time putting together the perfect chart again! This chart contains the most popular medical forms which are designed to keep information accurate and consistent for each patient. Each form is color coded for quick and easy access.

#### Each preassembled chart includes:

- Durable, 1 lpt reinforced tab file folder
- Two fasteners in positions #1 and #3
- Fileback with Lab/Test Results tab
- Six color-coded medical forms, printed head to toe
- Forms come in the order shown at right
- Sold in quantities of 100

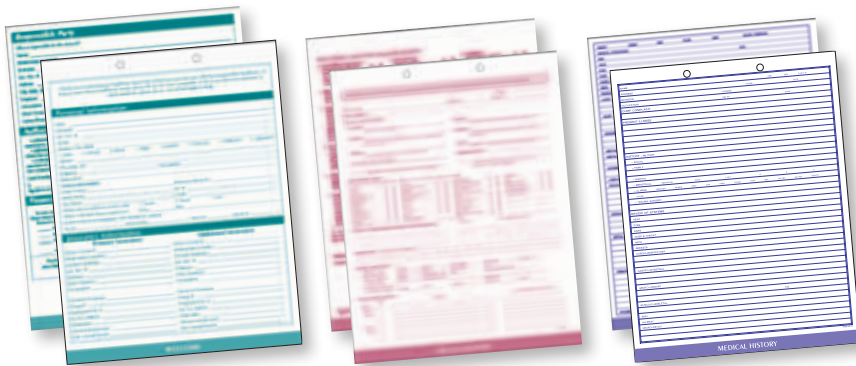
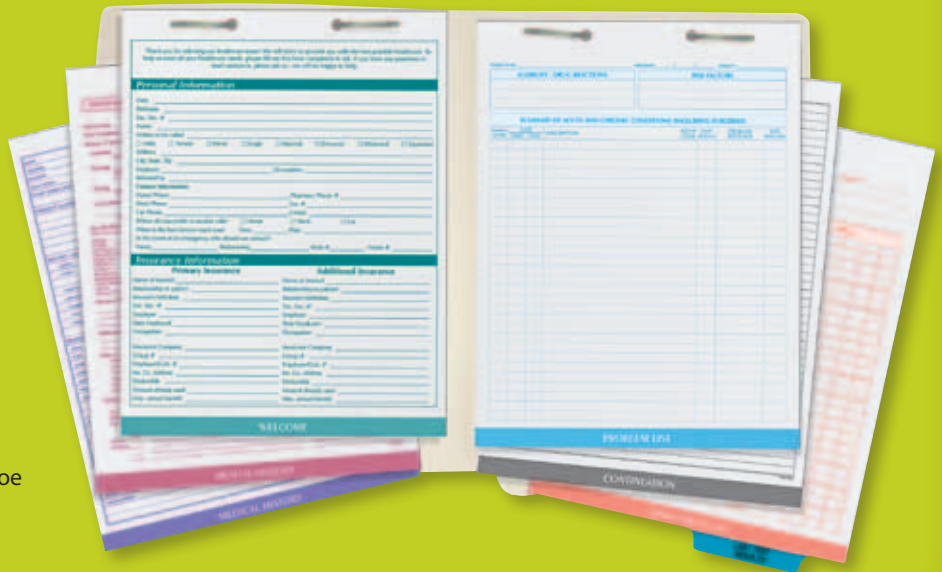

29010 (100/pkg)

29011 (100/pkg)

29012 (100/pkg)

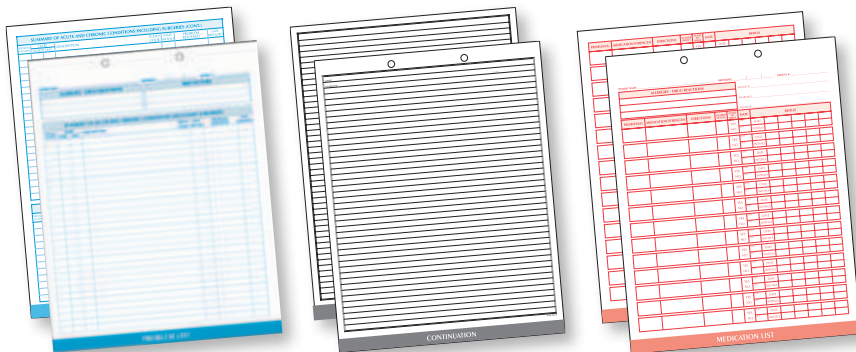

29013 (100/pkg)

29014 (100/pkg)

29015 (100/pkg)

### Individual \ Forms

Available in packages of 100

#### Welcome Form - (29010)

Welcome patients and gather patient information. This form is designed to make phone numbers and insurance information visible and easily accessible to staff.

#### Health History Form - (29011)

Used to gather detailed patient and family medical history. The yes/no format makes it easy for patients to complete.

#### Medical History/Physical Form - (29012)

Provides a record of the patient's physical examination with a space for the physician/clinician to note pertinent health or family history, assessment, diagnosis and care plan.

#### Continuation Sheet - (29013)

For recording patient visits, phone calls and other aspects of patient care.

#### Problem List Form - (29014)

Provides a comprehensive overview of a patient's medical status on one document.

#### Medication List Form - (29015)

A vital record of previous and current patient medications on one handy form for quick reference.

# Clinical Data Forms

## Mounting Sheets

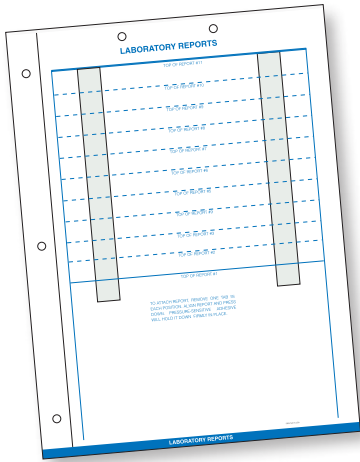

**CF8051**  
Laboratory Reports  
(100/pckg)



**CF3097**  
Telephone Messages  
(100/pckg)



**CF13415**  
Prescriptions  
(100/pckg)

## Growth Charts

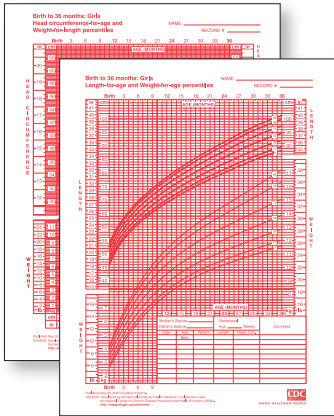

**PF13534NV**

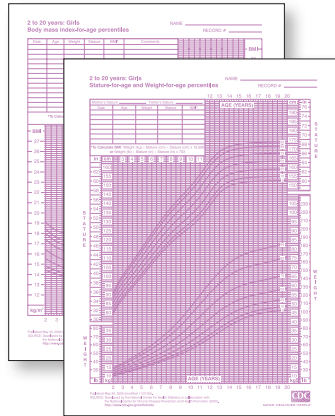

**PF13535NV**

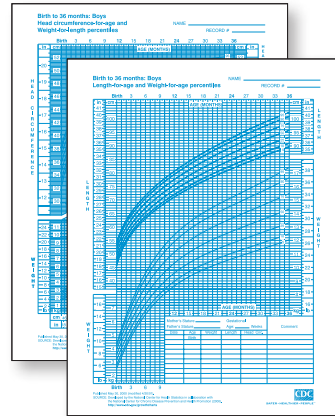

**PF13532NV**

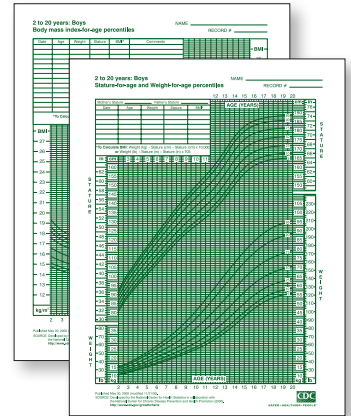

**PF13533NV**

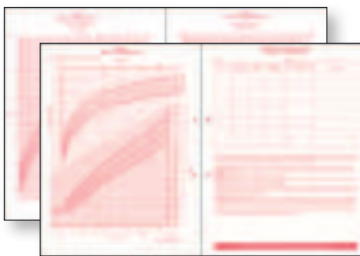

**PF13534**

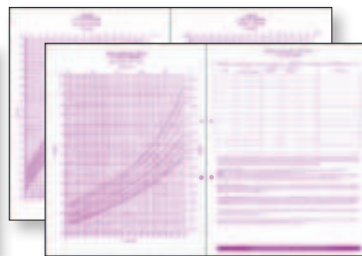

**PF13535**

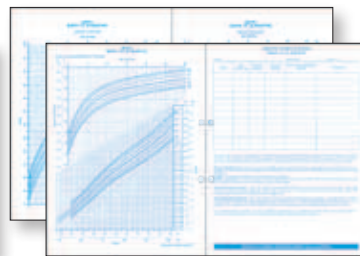

**PF13532**



**PF13533**



**CF16655**  
Medications List  
2 Sides (100/pkg)

**CF16656**  
Immunization Record  
(100/pkg)

**CF16653**  
Progress Notes  
2 Sides (100/pkg)

**CF16654**  
Problem List  
2 Sides (100/pkg)

**CF17659**  
Welcome - Patient Info  
2 Sides (100/pkg)

**CF16302**  
Welcome - Patient Reg  
(100/pkg)

**CF17659**  
Welcome - Patient Info  
2 Sides (100/pkg)

**CF17634**  
Patient Information  
(100/pkg)

**CF8288**  
Clinical Data Form  
with holes (100/pkg)

**CF8045**  
Progress Notes  
2 sides with holes (100/pkg)

**CF8290**  
Continuation Form  
with holes (100/pkg)

**CF8111**  
Continuation Form  
without holes (100/pkg)

## Evaluation & Management

**EM16786**  
Health History Form  
2 sides (200/pkg)

**EM16785**  
Patient Information  
1 side (200/pkg)

**EM16787**  
Physical Exam  
(200/pkg)

### Physical Exam Four-Page Booklet 8 1/2" x 11" folded

This booklet is designed to fully document the examination portion of an appointment. Covers general multi-system examinations.

# HCFA Forms

## HCFA Approved Medical Insurance Forms

All forms are government approved HCFA-1500 to serve federal programs and private insurers as a universal claim form. The 2-part form is carbonless. Revision (08-05)

Item	Description	Carton Qty
79109NPI	Cut Sheet	1000
79259NPI	Cut Sheet	2500
79106NPI	Continuous Sheet	1000
79256NPI	Continuous Sheet	2500
79120NPI	2-Part Continuous	1000



## Submission Envelopes

The window placement is specifically designed to have the insurance carrier's name and address show through the window (provided your computer prints out the insurance carrier's name and address in the upper right-hand corner.)

Available in regular moist & seal or convenient self-seal, both have security interior tint. Right hand window.

**HC10RG** Regular (9-1/2" x 4-1/8") Blank (500/box)

**HC10SS** Self-Seal (9-1/2" x 4-1/8") Blank (500/box)

Jumbo insurance envelope is designed to accommodate up to 50 insurance claims to the same carrier.

**HC912** Side-Seal HCFA Envelopes (9" x 13") (100/pkg.)

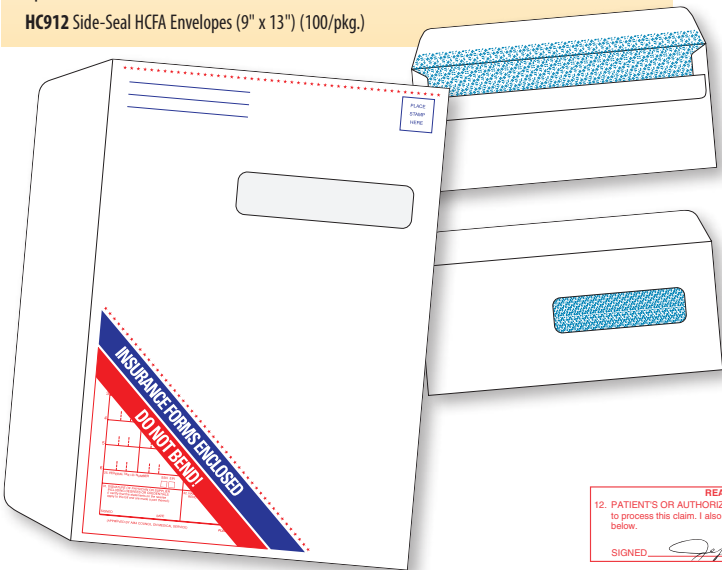

## Insurance Signature Release Labels

Save time by having patient sign several of these labels on their first visit. They can be used for subsequent claims as needed. Compatible with HCFA-1500 forms.

**7891HL** – 5/8" H x 7" W Self Adhesive Label (375 Labels per pack. 15 Labels per sheet)



READ BACK OF FORM BEFORE COMPLETING & SIGNING THIS FORM.

12. PATIENT'S OR AUTHORIZED PERSON'S SIGNATURE I authorize the release of any medical or other information necessary to process this claim. I also request payment of government benefits either to myself or to the party who accepts assignment below.

SIGNED Jeff Smith DATE 1-23-96

13. INSURED'S OR AUTHORIZED PERSON'S SIGNATURE I authorize the release of any medical or other information necessary to process this claim. I also request payment of government benefits either to myself or to the party who accepts assignment below.

SIGNED Jeff Smith

## SIGN-IN SHEETS



**14037 Salmon**  
(250/pkg)

**18229 Green**  
(250/pkg)

**18228 Blue**  
(250/pkg)

**17017 Fish**  
(100/pkg)

**17014 Toothbrush**  
(100/pkg)

**17008 Smile**  
(100/pkg)



**26999 - Complete Chart**  
(25 / box)

## PREASSEMBLED DENTAL SYSTEM MAKES YOUR PRACTICE MORE EFFICIENT!

### The Complete Dental System

Our popular, preassembled chart contains all the necessary forms a dental office needs, and costs less than purchasing each separately.

**Each preassembled chart includes:**

- Durable 11pt pocket folder (#MPFA-10) with 2" bonded fastener; an MSDA-11 file divider with a twin prong fastener; and a 5-mil poly pocket 8-3/4" W x 5-1/2" H.
- Eight (8) clinical forms

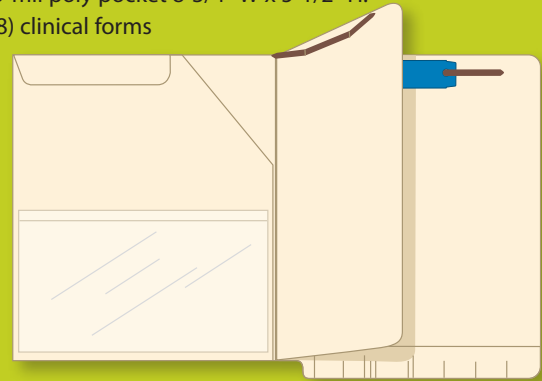

**26998 - Dental Records Folder - No Forms**  
(25 / box)

Individual forms are also available in packages of 100.

**Patient Registration – (27000)**  
gathers complete personal, billing, and insurance information.

**Recall Examination – (27002)**  
updates health information, exam history, x-ray history, hygiene instructions and more at subsequent visits.

**Progress Notes – (27003)**  
columns record tooth, anesthetic given and treatment documentation. 2 sides.

**Health History Update – (27004)**  
documents changes in health or medication.

**Correspondence Log – (27006)**  
tracks correspondence sent or received by the office.

**Clinical Examination – (27007)**  
documents patient's first visit, including chief complaint and existing or previous condition.

**Treatment Plan with Chart – (27009)**  
records exam on a diagram with additional space to document treatment plans and completion dates.

**Health History – (27011)**  
detailed medical and dental condition questions, previous dental treatments and more. 2 sides.

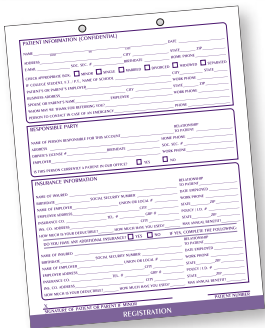

**27000**  
(100/pkg)

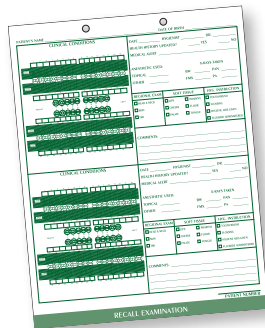

**27002**  
(100/pkg)

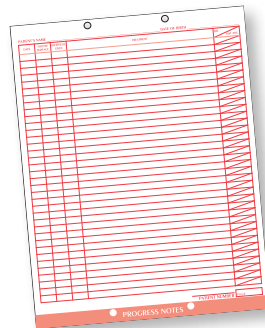

**27003**  
(100/pkg)

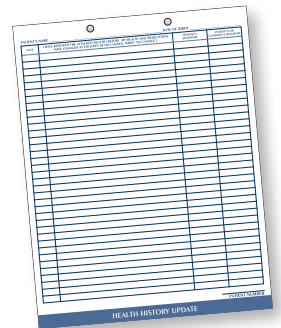

**27004**  
(100/pkg)

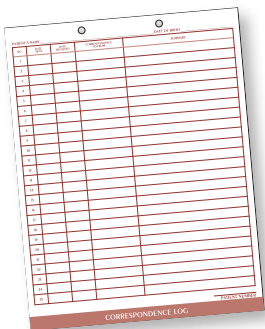

**27006**  
(100/pkg)

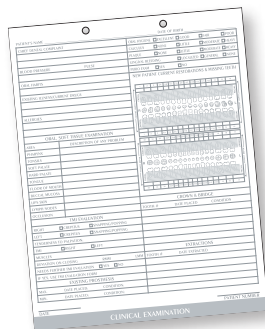

**27007**  
(100/pkg)

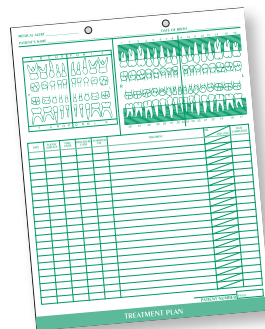

**27009**  
(100/pkg)

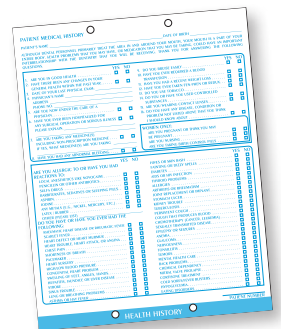

**27011**  
(100/pkg)

# Dental Forms

**DF9444 Four-Page Medical/ Dental Records**  
 Overall size: 11" x 17"  
 page size: 8-1/2" x 11" folded. (100/PKG)

This form includes sections for:
 

- PATIENT INFORMATION: NAME, ADDRESS, PHONE, DATE OF BIRTH, SEX, RACE, ETHNICITY, OCCUPATION, RELIGION, POLITICAL AFFILIATION, SOCIAL SECURITY NUMBER, MARITAL STATUS, EDUCATION, ALLERGIES, MEDICAL HISTORY, SURGICAL HISTORY, PRESENT MEDICATIONS, PREVIOUS DENTAL TREATMENT, DENTAL HISTORY, DENTAL X-RAYS, DENTAL RADIATION THERAPY, DENTAL ANESTHESIA, DENTAL PROCEDURES, DENTAL MATERIALS, DENTAL LABORATORY, DENTAL FINANCIAL, DENTAL COMPLAINTS, DENTAL EXAMINATION, DENTAL TREATMENT PLAN, DENTAL PROGNOSIS, DENTAL REFERENCE, DENTAL SIGNATURE, DENTAL DATE.
- EXAMINATION: PERIODONTAL, PULP, PERIAPICAL, ENDORHEAL, EXTRAORAL, INTRAORAL, RADIOGRAPHIC, LABORATORY, FINANCIAL, COMPLAINTS, EXAMINATION, TREATMENT PLAN, PROGNOSIS, REFERENCE, SIGNATURE, DATE.
- CHARGE SHEET: DATE, TOOTH, SERVICE, CHARGE, PAY, BALANCE.

**DF9123 80# Offset Opaque (100/PKG)**  
**DF9124 100# Index Stock (100/PKG)**

This form is a large grid for recording dental services. Columns include: DATE, TOOTH, SERVICE PERFORMED, CHARGE, PAY, BALANCE, TELEPHONE, ADDRESS, CITY, STATE, ZIP, COUNTRY.

**DF9420 80# Offset Opaque (100/PKG)**  
**DF9460 100# Index Stock (100/PKG)**

This form includes sections for:
 

- PATIENT INFORMATION: NAME, ADDRESS, PHONE, DATE OF BIRTH, SEX, RACE, ETHNICITY, OCCUPATION, RELIGION, POLITICAL AFFILIATION, SOCIAL SECURITY NUMBER, MARITAL STATUS, EDUCATION, ALLERGIES, MEDICAL HISTORY, SURGICAL HISTORY, PRESENT MEDICATIONS, PREVIOUS DENTAL TREATMENT, DENTAL HISTORY, DENTAL X-RAYS, DENTAL RADIATION THERAPY, DENTAL ANESTHESIA, DENTAL PROCEDURES, DENTAL MATERIALS, DENTAL LABORATORY, DENTAL FINANCIAL, DENTAL COMPLAINTS, DENTAL EXAMINATION, DENTAL TREATMENT PLAN, DENTAL PROGNOSIS, DENTAL REFERENCE, DENTAL SIGNATURE, DENTAL DATE.
- EXAMINATION: PERIODONTAL, PULP, PERIAPICAL, ENDORHEAL, EXTRAORAL, INTRAORAL, RADIOGRAPHIC, LABORATORY, FINANCIAL, COMPLAINTS, EXAMINATION, TREATMENT PLAN, PROGNOSIS, REFERENCE, SIGNATURE, DATE.
- CHARGE SHEET: DATE, TOOTH, SERVICE PERFORMED, CHARGE, PAY, BALANCE, TELEPHONE, ADDRESS, CITY, STATE, ZIP, COUNTRY.

**DF9724 80# Offset Opaque (100/PKG)**  
**DF9764 100# Index Stock (100/PKG)**

This form includes sections for:
 

- PATIENT INFORMATION: NAME, ADDRESS, PHONE, DATE OF BIRTH, SEX, RACE, ETHNICITY, OCCUPATION, RELIGION, POLITICAL AFFILIATION, SOCIAL SECURITY NUMBER, MARITAL STATUS, EDUCATION, ALLERGIES, MEDICAL HISTORY, SURGICAL HISTORY, PRESENT MEDICATIONS, PREVIOUS DENTAL TREATMENT, DENTAL HISTORY, DENTAL X-RAYS, DENTAL RADIATION THERAPY, DENTAL ANESTHESIA, DENTAL PROCEDURES, DENTAL MATERIALS, DENTAL LABORATORY, DENTAL FINANCIAL, DENTAL COMPLAINTS, DENTAL EXAMINATION, DENTAL TREATMENT PLAN, DENTAL PROGNOSIS, DENTAL REFERENCE, DENTAL SIGNATURE, DENTAL DATE.
- EXAMINATION: PERIODONTAL, PULP, PERIAPICAL, ENDORHEAL, EXTRAORAL, INTRAORAL, RADIOGRAPHIC, LABORATORY, FINANCIAL, COMPLAINTS, EXAMINATION, TREATMENT PLAN, PROGNOSIS, REFERENCE, SIGNATURE, DATE.
- CHARGE SHEET: DATE, TOOTH, SERVICE PERFORMED, CHARGE, PAY, BALANCE, TELEPHONE, ADDRESS, CITY, STATE, ZIP, COUNTRY.

**DF1429 Examination Slips**  
 5-1/2" x 3-1/2", 20# offset, 100 slips per pad, 5 pads per box. Printed in green ink.

This form is used for recording dental examination findings. It includes sections for:
 

- PATIENT INFORMATION: NAME, ADDRESS, PHONE, DATE OF BIRTH, SEX, RACE, ETHNICITY, OCCUPATION, RELIGION, POLITICAL AFFILIATION, SOCIAL SECURITY NUMBER, MARITAL STATUS, EDUCATION, ALLERGIES, MEDICAL HISTORY, SURGICAL HISTORY, PRESENT MEDICATIONS, PREVIOUS DENTAL TREATMENT, DENTAL HISTORY, DENTAL X-RAYS, DENTAL RADIATION THERAPY, DENTAL ANESTHESIA, DENTAL PROCEDURES, DENTAL MATERIALS, DENTAL LABORATORY, DENTAL FINANCIAL, DENTAL COMPLAINTS, DENTAL EXAMINATION, DENTAL TREATMENT PLAN, DENTAL PROGNOSIS, DENTAL REFERENCE, DENTAL SIGNATURE, DENTAL DATE.
- EXAMINATION: PERIODONTAL, PULP, PERIAPICAL, ENDORHEAL, EXTRAORAL, INTRAORAL, RADIOGRAPHIC, LABORATORY, FINANCIAL, COMPLAINTS, EXAMINATION, TREATMENT PLAN, PROGNOSIS, REFERENCE, SIGNATURE, DATE.

**DF152 80# Offset Opaque (100/PKG)**

This form includes sections for:
 

- PATIENT INFORMATION: NAME, ADDRESS, PHONE, DATE OF BIRTH, SEX, RACE, ETHNICITY, OCCUPATION, RELIGION, POLITICAL AFFILIATION, SOCIAL SECURITY NUMBER, MARITAL STATUS, EDUCATION, ALLERGIES, MEDICAL HISTORY, SURGICAL HISTORY, PRESENT MEDICATIONS, PREVIOUS DENTAL TREATMENT, DENTAL HISTORY, DENTAL X-RAYS, DENTAL RADIATION THERAPY, DENTAL ANESTHESIA, DENTAL PROCEDURES, DENTAL MATERIALS, DENTAL LABORATORY, DENTAL FINANCIAL, DENTAL COMPLAINTS, DENTAL EXAMINATION, DENTAL TREATMENT PLAN, DENTAL PROGNOSIS, DENTAL REFERENCE, DENTAL SIGNATURE, DENTAL DATE.
- EXAMINATION: PERIODONTAL, PULP, PERIAPICAL, ENDORHEAL, EXTRAORAL, INTRAORAL, RADIOGRAPHIC, LABORATORY, FINANCIAL, COMPLAINTS, EXAMINATION, TREATMENT PLAN, PROGNOSIS, REFERENCE, SIGNATURE, DATE.
- CHARGE SHEET: DATE, TOOTH, SERVICE PERFORMED, CHARGE, PAY, BALANCE, TELEPHONE, ADDRESS, CITY, STATE, ZIP, COUNTRY.

**DF0420 Patient Records**  
 Folds to 5" x 8", 80# offset opaque (100/PKG)  
 Printed in green ink.

## Dazzling Designs! Easy to Print! Cost Effective!

Laser Recall Cards Provide the Ultimate Flexibility for Communication with Patients

Choose from a wide variety of vibrant graphics and attention grabbing designs

- Standard 8-1/2" X 11" stock feeds smoothly through laser printers
- Cards are blank on one side allowing for customized messages & practice information
- Each sheet has four 4-1/4" x 5-1/2" cards, micro-perforated for easy separation
- Sold in 25 sheet packages (100 cards)

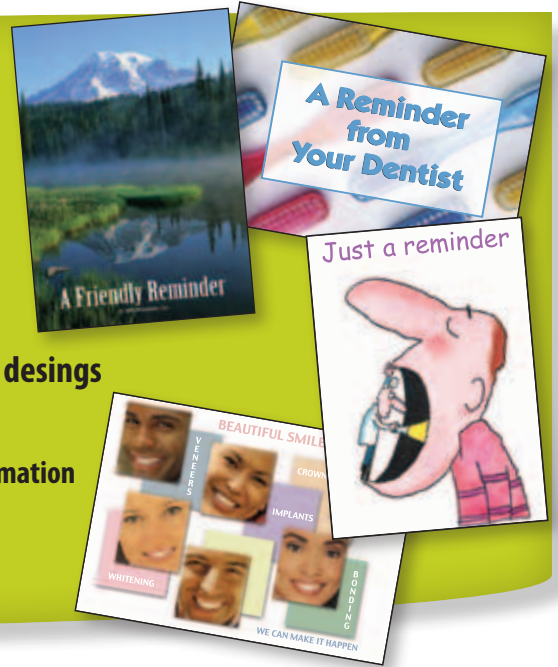

## Cartoons

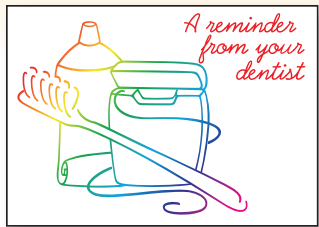

RC151

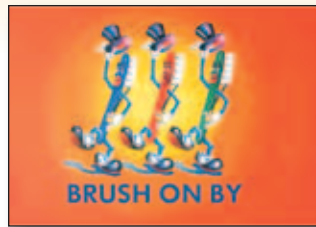

RC158



RC172



RC102



RC180

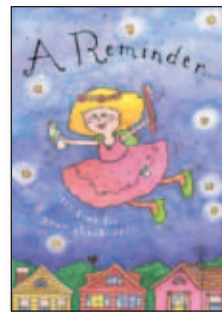

RC113



RC122

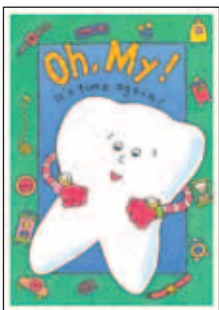

RC126



RC128



RC143

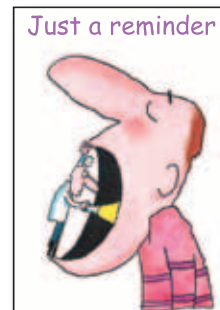

RC181



RC182

# Reminder Cards

## Toothbrushes



RC161



RC101

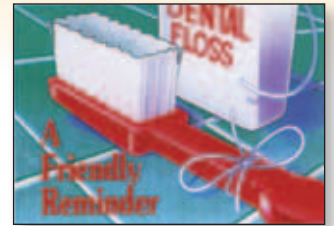

RC111

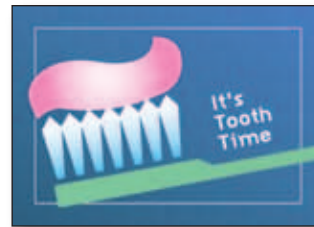

RC115



RC141



RC160



RC100



RC150



RC131



RC164



RC173

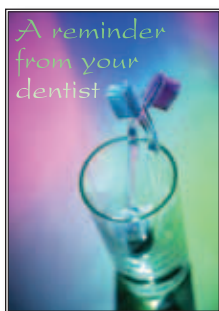

RC166



RC137



RC170



RC108

# Reminder Cards

## Designer



RC144



RC114



RC146

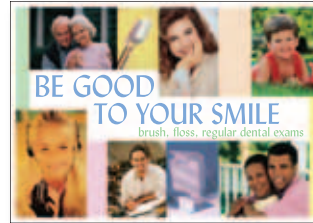

RC169



RC154



RC120



RC129



RC147

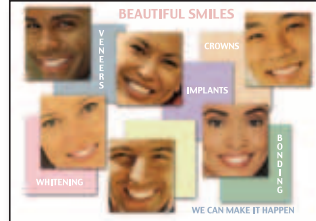

RC162



RC156



RC157



RC177



RC175



RC167



RC104



RC152

## Animals



RC121



RC133

# Reminder Cards

## Nature



RC174



RC186



RC155

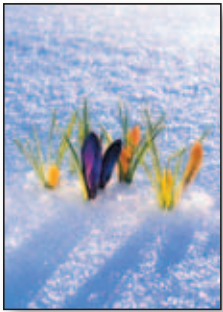

RC168



RC118



RC130



RC138

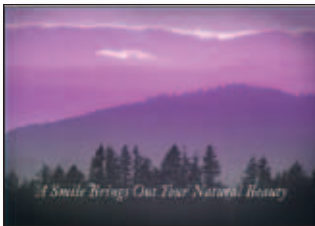

RC139



RC123



RC165



RC171



RC176



RC178



RC179



RC183



RC184



RC185



RC107



# Portable Filing Storage Units

## 35" W Two Filing Shelves FileCart™

Transporting files is easy with the two-shelf FileCart. The two angled shelves save time by allowing for easy access. Also included are two movable dividers. Made of heavy-duty 18 gauge steel. Available in bone or light gray. 35" W x 16" D x 34" H.



### 35" W Two Filing Shelves FileCart™

Stock No.	No. of Shelves	File Capacity
DFC465 (Bone)	2	64"
DFC466 (Lt. Gray)	2	64"

Assembly required.

## Laminate Top Add-On for FileCarts™

Instantly creates a mobile workstation for increased efficiency. Designed to work with the One Filing/One Utility Shelf FileCart or the Two Filing Shelves FileCart. Available in bone or light gray. Includes mounting hardware. 35-3/8" W x 16-1/4" D x 58" H.

Stock No.	Color
DFC228	Bone
DFC244	Lt. Gray

Assembly required.

### Filing Unit/ Divider Colors

Lt. Gray
Bone White



## Movable Dividers

Movable dividers offer a higher level of organization. Separate charting as needed for a more efficient filing and better overall organization. Perfect for any FileCart model. Available in bone or light gray.



Add multiple sets of movable dividers easily!

### Movable Dividers

Stock No.	No. of Dividers
DFC467 (Bone)	4
DFC468 (Lt. Gray)	4

## 26" W Under-the-Counter FileCart™

Slide this FileCart under any standard desktop or countertop to save desk and floor space. The angled shelves make locating files quick and easy. Available in bone or light gray. 26" W x 16" D x 27" H.



### 26" W Under-the-Counter FileCart™

Stock No.	No. of Shelves	File Capacity
DFC269 (Bone)	2	46"
DFC285 (Lt. Gray)	2	46"

Assembly required.

## 42" W Deluxe Transport Cart

Move this workstation to wherever it's needed. Adjustable shelves make storing files a snap. Available with or without locking doors in putty or gray. 42" W x 17-5/8" D x 45" H.

### 42" W Deluxe Transport Cart

Stock No.	No. of Shelves	File Capacity
DFC153 (Putty)	3	105"
DFC154 (Gray)	3	105"

Assembly required.

### 42" W Deluxe Transport Cart without Doors

Stock No.	No. of Shelves	File Capacity
DFC155 (Putty)	3	105"
DFC156 (Gray)	3	105"

Assembly required.

Putty
Gray



# Security Storage Systems

## Economy LapTop Cart

Item #	Description	W	D	H	Est. Lbs.
LTCE-PC16	Economy laptop cart, laminate top	35-3/8"	16-1/4"	34-1/2"	80
LTCE-PC16TD	Economy laptop cart, locking tambour door, no laminate top	35"	19-3/4"	38"	102
CSC-OS16	16 outlet 8' cord power strip 17-1/4" (18-1/2" w/mounting strips)				3

Carts with tambour door are keyed alike. To specify keyed differently, add the suffix "D"

## LapTop Cart

Item #	Description	W	D	H	Est. Lbs.
CSC-PC20UL	20 Laptop Charging & Storing UL Approved Cart	30-1/4"	26-1/4"	37-7/8"	184
CSC-PC26UL	26 Laptop Charging & Storing UL Approved Cart	35-7/8"	26-1/4"	37-7/8"	206
CSC-PC32UL	32 Laptop Charging & Storing UL Approved Cart	41-7/8"	26-1/4"	37-7/8"	228

## NetBook Cart

Item #	Description	W	D	H	Est. Lbs.
CSC-ML30	30 Netbook Charging & Storing	30-1/4"	26-1/4"	37-7/8"	184
CSC-ML48	48 Netbook Charging & Storing	43-3/16"	26-1/4"	37-7/8"	238
CSC-CM20	20 Netbook Charging & Storing	30-1/4"	26-1/4"	37-7/8"	184
CSC-CM26	26 Netbook Charging & Storing	35-7/8"	26-1/4"	37-7/8"	206
CSC-CM32	32 Netbook Charging & Storing	41-7/8"	26-1/4"	37-7/8"	208

\*Handle adds 4-7/8" to the overall width of the cart.

Rear doors keyed alike. To have them keyed differently, add the suffix "D"

## Options

Item #	Description	Est. Lbs.
CSC-PWR	Pop Up Power Center (2 outlets)	2
CSC-CAT5	CAT5 Cable Jack (Available only when unit has Pop Up Power Center)	1
CSC-H	Extra Handle/Cord Wrap Combination	2
CSC-SYPL	Masterlock® - Set Yourself Padlock	1
CSC-8	8" Casters - Customer Installation Only	20

## Laptop Depot

Item #	Description	H	W	D	Est. Lbs.
LTD5	5 laptop unit	17"	14"	22"	65
LTD8	8 laptop unit	17"	20"	22"	85

All LTD models are for securing and charging laptops.

Locking doors & UL approved electrical components standard on all models of LTD.

Locking drawer standard on all LTD models.

All units come standard keyed alike. To have them keyed differently, add the suffix "D"

## Laptop Locker

Item #	Description	H	W	D	Est. Lbs.
LTL1	Standard LapTop Locker	16"	3-1/2"	13-13/16"	16
LTL-2K	Key Lock	14-1/2"	18"	3-1/2"	16
LTL-2H	Hasp Lock	14-1/2"	18"	3-1/2"	17
LTL-2C	Electronic Lock	14-1/2"	18"	3-1/2"	18

Standard LapTop Lockers (LTL1) are standard keyed alike.

To have them keyed differently, add the suffix "D".

## WallWrite®

WallWrite® is a unique solution for high-traffic areas where placement of a desk or traditional workstation isn't feasible. The WallWrite® features a unique flip-down door that serves as a writing surface, while conserving floor space.

### Key Features

#### Security

WallWrite® secures and protects confidential materials. In healthcare applications, it is even HIPAA compliant.

#### Convenience

Materials stored in a WallWrite® are easily accessible without obtrusive filing cabinets or shelves.

WallWrite® desks offer convenient storage of reference materials, patient charts, MSDS binders, and supplies. The unit is perfect in exam rooms, nursing stations, loading docks, warehouses, supply rooms and more.

### WallWrite Fold-Up Desk

WW-101	WallWrite Fold Up Desk Non - Locking
WW-100	WallWrite Fold Up Desk Locking
WW-101DB	WallWrite Fold Up Desk Dropbox Non - Locking
WW-100DB	WallWrite Fold Up Desk Dropbox Locking

Available in bone white or light gray



# Stackable Shelving and Track Systems



## STRAIGHT SHELVING

Modular design allows tiers to be stacked up to eight levels high. All tiers come with welded dividers to keep the files upright. Shelves are also available 24" wide. Straight shelves maximize storage capacity while minimizing the use of valuable floor space.

## SLANTED SHELVES

The 55 degree angled design provides increased visibility of the color coding on the folders. Slanted shelving allows the end-tabs of each folder to extend past the next for faster retrieval. Additional tiers can be added at any time to increase file capacity. Shelves are also available 24" wide.

## WARRANTY

All shelving and track systems include a manufacturer's lifetime warranty. Certain stipulations apply. Ask for a copy of the warranty for details.

**Allow 1-2 weeks for delivery.**

Putty
Lt. Gray

## Straight Shelving

Pre-Configured Shelving

**DIMENSIONS** (Nominal)

Size	A	B	C
24"	10-3/8"	12-1/4"	24"
36"	10-3/8"	12-1/4"	36"
48"	10-3/8"	12-1/4"	48"

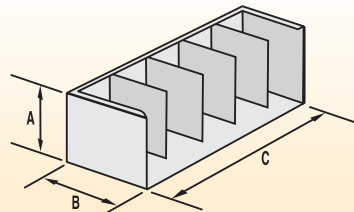
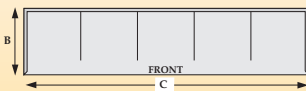

Colors Available - Putty or Lt. Gray  
Specify color when ordering

## Slanted Shelving

Pre-Configured Shelving

**DIMENSIONS** (Nominal)

Size	A	B	C	D
24"	10-3/8"	10"	24"	30-3/8"
36"	10-3/8"	10"	36"	42-3/16"
48"	10-3/8"	10"	48"	54-13/16"

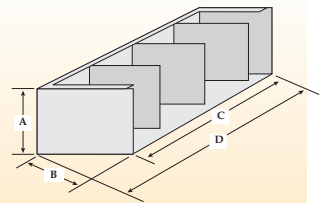
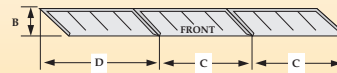

Colors Available - Putty or Lt. Gray  
Specify color when ordering

## 36" Wide Straight Shelving (Includes top and base)

Description	File Capacity	Height	Stock No.	Weight
2 Shelves High	72"	22.75"	9002FS	52 lbs.
3 Shelves High	108"	33.00"	9003FS	70 lbs.
4 Shelves High	144"	43.50"	9004FS	88 lbs.
5 Shelves High	180"	54.00"	9005FS	106 lbs.
6 Shelves High	216"	64.25"	9006FS	124 lbs.
7 Shelves High	252"	74.50"	9007FS	142 lbs.
8 Shelves High	288"	85.00"	9008FS	160 lbs.

## 48" Wide Straight Shelving (Includes top and base)

Description	File Capacity	Height	Stock No.	Weight
2 Shelves High	96"	22.75"	D98012ST	70 lbs.
3 Shelves High	144"	33.00"	D98013ST	94 lbs.
4 Shelves High	192"	43.50"	D98014ST	118 lbs.
5 Shelves High	240"	54.00"	D98015ST	142 lbs.
6 Shelves High	288"	64.25"	D98016ST	166 lbs.
7 Shelves High	336"	74.50"	D98017ST	190 lbs.
8 Shelves High	384"	85.00"	D98018ST	214 lbs.

## 36" Wide Slanted Shelving (Includes top and base)

Description	File Capacity	Height	Stock No.	Weight
2 Shelves High	58"	22.75"	9502SFS	52 lbs.
3 Shelves High	87"	33.00"	9503SFS	70 lbs.
4 Shelves High	116"	43.50"	9504SFS	88 lbs.
5 Shelves High	145"	54.00"	9505SFS	106 lbs.
6 Shelves High	174"	64.25"	9506SFS	124 lbs.
7 Shelves High	203"	74.50"	9507SFS	142 lbs.
8 Shelves High	232"	85.00"	9508SFS	160 lbs.

## 48" Wide Slanted Shelving (Includes top and base)

Description	File Capacity	Height	Stock No.	Weight
2 Shelves High	80"	22.75"	D9802SL	70 lbs.
3 Shelves High	120"	33.00"	D9803SL	94 lbs.
4 Shelves High	160"	43.50"	D9804SL	118 lbs.
5 Shelves High	200"	54.00"	D9805SL	142 lbs.
6 Shelves High	240"	64.25"	D9806SL	166 lbs.
7 Shelves High	280"	74.50"	D9807SL	190 lbs.
8 Shelves High	320"	85.00"	D9808SL	214 lbs.

## Quality Construction

Synonymous with strength and durability, all shelving features a 20 gauge back-side made from one piece of steel. Each side has a 20 gauge welded bottom, and each shelf has four 20 gauge welded dividers that extend the full height of the shelf. The front of each shelf has a double hem for smoothness and added strength.

The top finishing unit is made from 20 gauge cold rolled steel. The base unit is constructed of 20 gauge channels that are welded and reinforced.

## Easy Assembly

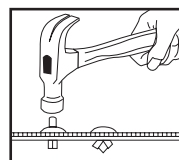

Each tier is fully assembled and ready to stack and connect in a matter of minutes with simple drive rivets.

2" Base

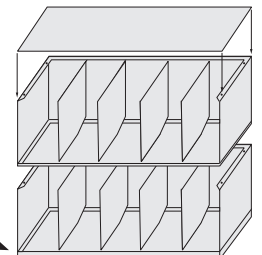

# Stackable Shelving and Track Systems



Putty  
Lt. Gray

## TRACK STORAGE SYSTEMS

Get maximum storage capacity from your valuable floor space with a moveable shelving system.

- Increase file capacity 50% to 75%.
- Shelving is compatible with many popular brands, making it easy to expand your existing filing system or create a flexible new one.

### Straight & Slanted Moveable Shelving Systems

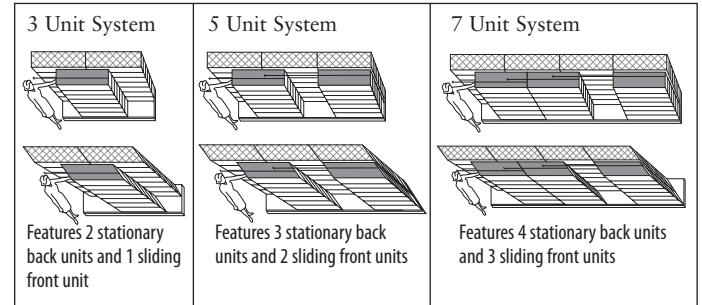

### Pre-Configured Straight Moveable Systems

#### 36" Wide Straight Moveable Shelving System

These complete systems include shelving and track.

Description	Capacity	Width*	Height*	Stock No.	Weight
<b>2 Fixed x 1 Moveable (Includes 3 Units and Track)</b>					
5 Shelves High	540"	76"	58.00"	5HDT2X1-ST36	419 lbs.
6 Shelves High	648"	76"	68.25"	6HDT2X1-ST36	473 lbs.
7 Shelves High	756"	76"	78.50"	7HDT2X1-ST36	527 lbs.
<b>3 Fixed x 2 Moveable (Includes 5 Units and Track)</b>					
5 Shelves High	900"	112"	58.00"	5HDT3X2-ST36	694 lbs.
6 Shelves High	1080"	112"	68.25"	6HDT3X2-ST36	784 lbs.
7 Shelves High	1260"	112"	78.50"	7HDT3X2-ST36	874 lbs.
<b>4 Fixed x 3 Moveable (Includes 7 Units and Track)</b>					
5 Shelves High	1260"	148"	58.00"	5HDT4X3-ST36	969 lbs.
6 Shelves High	1512"	148"	68.25"	6HDT4X3-ST36	1095 lbs.
7 Shelves High	1764"	148"	78.50"	7HDT4X3-ST36	1221 lbs.

#### 48" Wide Straight Moveable Shelving System

These complete systems include shelving and track.

Description	Capacity	Width*	Height*	Stock No.	Weight
<b>2 Fixed x 1 Moveable (Includes 3 Units and Track)</b>					
5 Shelves High	720"	100"	58.00"	5HDT2X1-ST48	521 lbs.
6 Shelves High	864"	100"	68.25"	6HDT2X1-ST48	593 lbs.
7 Shelves High	1008"	100"	78.50"	7HDT2X1-ST48	665 lbs.
<b>3 Fixed x 2 Moveable (Includes 5 Units and Track)</b>					
5 Shelves High	1200"	148"	58.00"	5HDT3X2-ST48	864 lbs.
6 Shelves High	1440"	148"	68.25"	6HDT3X2-ST48	984 lbs.
7 Shelves High	1680"	148"	78.50"	7HDT3X2-ST48	1104 lbs.
<b>4 Fixed x 3 Moveable (Includes 7 Units and Track)</b>					
5 Shelves High	1680"	196"	58.00"	5HDT4X3-ST48	1207 lbs.
6 Shelves High	2016"	196"	68.25"	6HDT4X3-ST48	1375 lbs.
7 Shelves High	2352"	196"	78.50"	7HDT4X3-ST48	1543 lbs.

### Pre-Configured Slanted Moveable Systems

#### 36" Wide Slanted Moveable Shelving System

These complete systems include shelving and track.

Description	Capacity	Width*	Height*	Stock No.	Weight
<b>2 Fixed x 1 Moveable (Includes 3 Units and Track)</b>					
5 Shelves High	435"	89"	58.00"	5HDT2X1-SL36	429 lbs.
6 Shelves High	522"	89"	68.25"	6HDT2X1-SL36	483 lbs.
7 Shelves High	609"	89"	78.50"	7HDT2X1-SL36	537 lbs.
<b>3 Fixed x 2 Moveable (Includes 5 Units and Track)</b>					
5 Shelves High	725"	125"	58.00"	5HDT3X2-SL36	704 lbs.
6 Shelves High	870"	125"	68.25"	6HDT3X2-SL36	794 lbs.
7 Shelves High	1015"	125"	78.50"	7HDT3X2-SL36	884 lbs.
<b>4 Fixed x 3 Moveable (Includes 7 Units and Track)</b>					
5 Shelves High	1015"	161"	58.00"	5HDT4X3-SL36	979 lbs.
6 Shelves High	1218"	161"	68.25"	6HDT4X3-SL36	1105 lbs.
7 Shelves High	1421"	161"	78.50"	7HDT4X3-SL36	1231 lbs.

#### 48" Wide Slanted Moveable Shelving System

These complete systems include shelving and track.

Description	Capacity	Width*	Height*	Stock No.	Weight
<b>2 Fixed x 1 Moveable (Includes 3 Units and Track)</b>					
5 Shelves High	600"	113"	58.00"	5HDT2X1-SL48	541 lbs.
6 Shelves High	720"	113"	68.25"	6HDT2X1-SL48	613 lbs.
7 Shelves High	840"	113"	78.50"	7HDT2X1-SL48	685 lbs.
<b>3 Fixed x 2 Moveable (Includes 5 Units and Track)</b>					
5 Shelves High	1000"	161"	58.00"	5HDT3X2-SL48	894 lbs.
6 Shelves High	1200"	161"	68.25"	6HDT3X2-SL48	1014 lbs.
7 Shelves High	1400"	161"	78.50"	7HDT3X2-SL48	1124 lbs.
<b>4 Fixed x 3 Moveable (Includes 7 Units and Track)</b>					
5 Shelves High	1400"	209"	58.00"	5HDT4X3-SL48	1227 lbs.
6 Shelves High	1680"	209"	68.25"	6HDT4X3-SL48	1395 lbs.
7 Shelves High	1960"	209"	78.50"	7HDT4X3-SL48	1563 lbs.

\*Widths listed above include an additional 4" for carriage over-travel on each side of the system. The heights include an additional 4" for leveling bases and wheels.

# Stackable Shelving and Track Systems

## Straight Shelving Individual Components

### 24" Shelving Components

Description	Color	Stock No.	Weight
Single Shelf	Putty	9300FS	15 lbs.
Single Shelf	Lt. Gray	9301FSGY	15 lbs.
Top and Base Units	Putty	9310TB	14 lbs.
Top and Base Units	Lt. Gray	9311TBGY	14 lbs.
Spacer	Putty	9330SP	12 lbs.
Spacer	Lt. Gray	9331SPGY	12 lbs.

### 36" Shelving Components

Description	Color	Stock No.	Weight
Single Shelf	Putty	9000FS	18 lbs.
Single Shelf	Lt. Gray	9001FSGY	18 lbs.
Top and Base Units	Putty	9010TB	16 lbs.
Top and Base Units	Lt. Gray	9011TBGY	16 lbs.
Pull Out, Posting Shelf	Putty	9020RS	18 lbs.
Pull Out, Posting Shelf	Lt. Gray	9021RSGY	18 lbs.
Spacer	Putty	9030SP	14 lbs.
Spacer	Lt. Gray	9031SPGY	14 lbs.

### 48" Shelving Components

Description	Color	Stock No.	Weight
Single Shelf	Putty	D981ST	24 lbs.
Single Shelf	Lt. Gray	D981STGY	24 lbs.
Top and Base Units	Putty	D9811TB	22 lbs.
Top and Base Units	Lt. Gray	D9811TBGY	22 lbs.
Pull Out, Posting Shelf	Putty	D9812PS	20 lbs.
Pull Out, Posting Shelf	Lt. Gray	D9812PSGY	20 lbs.
Spacer	Putty	D9813SP	16 lbs.
Spacer	Lt. Gray	D9813SPGY	16 lbs.

## Slanted Shelving Individual Components

### 24" Shelving Components

Description	Color	Stock No.	Weight
Single Shelf	Putty	9400SFS	15 lbs.
Single Shelf	Lt. Gray	9401SFSGY	15 lbs.
Top and Base Units	Putty	9410STB	14 lbs.
Top and Base Units	Lt. Gray	9411STBGY	14 lbs.
Spacer	Putty	9430SSP	12 lbs.
Spacer	Lt. Gray	9431SSPGY	12 lbs.

### 36" Shelving Components

Description	Color	Stock No.	Weight
Single Shelf	Putty	9500SFS	18 lbs.
Single Shelf	Lt. Gray	9501SFSGY	18 lbs.
Top and Base Units	Putty	9510STB	16 lbs.
Top and Base Units	Lt. Gray	9511STBGY	16 lbs.
Pull Out, Posting Shelf	Putty	9520SRS	18 lbs.
Pull Out, Posting Shelf	Lt. Gray	9521SRSGY	18 lbs.
Spacer	Putty	9530SSP	14 lbs.
Spacer	Lt. Gray	9531SSPGY	14 lbs.

### 48" Shelving Components

Description	Color	Stock No.	Weight
Single Shelf	Putty	D980SL	24 lbs.
Single Shelf	Lt. Gray	D980SLGY	24 lbs.
Top and Base Units	Putty	D981TB	22 lbs.
Top and Base Units	Lt. Gray	D981TBGY	22 lbs.
Pull Out, Posting Shelf	Putty	D982PS	20 lbs.
Pull Out, Posting Shelf	Lt. Gray	D982PSGY	20 lbs.
Spacer	Putty	D983SP	16 lbs.
Spacer	Lt. Gray	D983SPGY	16 lbs.

**SINGLE SHELF:** Each shelving tier features welded dividers for keeping folders upright.

**TOP AND BASE:** The base unit is 2" high overall and the top panel is flush with top tier, adding no height. One top and base set is required for each stack of shelves.

**PULL-OUT POSTING SHELF:** Add a posting shelf to your shelving system to create a workstation with a sturdy writing surface. The posting shelf adds 2" to the height of each unit.

**SPACER:** The spacer adds 2" to the height of each unit.



**Gang-Locking**  
One key locks all doors at both ends simultaneously for added security.

**Posting Shelf**  
Optional posting shelf adds a convenient work surface to Stak-N-Lok™ files.

**Flip Up Doors**  
Fully retractable doors store out of the way for easy file retrieval and replacement.

**Adjustable Dividers**  
Fixed shelves feature movable dividers to keep files neat and organized.

### Preassembled Stak-N-Lok Shelving Units

Does not include pull-out shelf - Keyed at top

Tiers	Height	STOCK NUMBER	
		36" Wide	42" Wide
2H	28"	SL362	SL422
3H	40"	SL363	SL423
4H	52"	SL364	SL424
5H	64"	SL365	SL425
6H	76"	SL366	SL426
7H	88"	SL367	SL427

### Preassembled Stak-N-Lok Shelving Units

Includes pull-out shelf - Keyed in middle

Tiers	Height	STOCK NUMBER	
		36" Wide	42" Wide
5H	66-1/2"	SLP365	SLP425
6H	78-1/2"	SLP366	SLP426
7H	90-1/2"	SLP367	SLP427

### Preassembled Stak-N-Lok Shelving Units

Includes spacer - Keyed in middle

Tiers	Height	STOCK NUMBER	
		36" Wide	42" Wide
5H	66-1/2"	SLS365	SLS425
6H	78-1/2"	SLS366	SLS426
7H	90-1/2"	SLS367	SLS427

### Accessories

DESCRIPTION	STOCK NUMBER
Package of eight moveable plate dividers	DSPD8

- Overall Height 16" H
- Inside Depth 13-5/8"
- Outside Depth 15"
- Tiers 12" H
- Base 2" H
- Posting Shelf 2" H

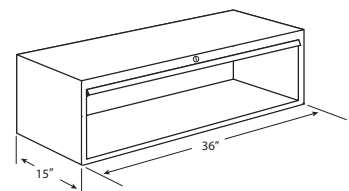

# Stackable Shelving and Track Systems

## STAK-N-LOK™

Stack-N-Lok™ modular design allows for efficient use of available workspace. Including convenient gang-locking doors, Stak-N-Lok files offer all the security and storage benefits of a standard lateral file while taking up 27% less floor space. Initial orders will come from the factory pre-assembled, but the unique stackable feature allows you to add additional tiers in the future to increase file capacity.

**Track Systems:** Further increase capacity with minimal increase in floor space, the track system can be installed new or can be easily added in the future.

**Specifications:** Extra heavyweight 16-gauge track and deck. 14-gauge welded steel carriage system with 2-3/16" sealed bearing nylon wheels. Each carriage is fully welded with a static load capacity of 3500 lbs. Units (tiers) come fully assembled and ready to attach to carriages. All units and track components have a scratch-resistant powder-coat finish in a choice of Bone White or Light Gray ( track, carriage and anti-tip rail are black only).

**Units shipped FOB factory. Allow 2-3 weeks for delivery.**



### Stak-N-Lok™ Pre-Configured Track Systems (All Units 29" Deep)

Units with no shelf or spacer

**Include:**

- Gang-lock at top of each unit.

**Height**

- 6H units are 81-1/2" high
- 7H units are 93-1/2" high

Units with a shelf and spacer

**Include:**

- Only the sliding front units include a shelf.
- Stationary back units include a spacer.
- Gang-lock at middle of each unit.

**Height**

- 6H units are 84" high
- 7H units are 96" high

#### 3 Unit System

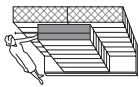

Features 2 stationary back units and 1 sliding front unit

#### 36" Shelving / 76" WIDE

HT	Shelf	LFI	Stock No.	Weight
6H	No	621"	SL36676	611
6H	Yes	621"	SLP36676	740
7H	No	746"	SL36776	686
7H	Yes	746"	SLP36776	815

#### 42" Shelving / 88" Wide

HT	Shelf	LFI	Stock No.	Weight
6H	No	729"	SL42688	704
6H	Yes	729"	SLP42688	833
7H	No	851"	SL42788	788
7H	Yes	851"	SLP42788	917

#### 5 Unit System

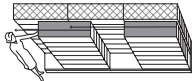

Features 3 stationary back units and 2 sliding front units

#### 36" Shelving / 112" Wide

HT	Shelf	LFI	Stock No.	Weight
6H	No	1,035"	SL366112	1,014
6H	Yes	1,035"	SLP366112	1,279
7H	No	1,243"	SL367112	1,139
7H	Yes	1,243"	SLP367112	1,499

#### 42" Shelving / 130" Wide

HT	Shelf	LFI	Stock No.	Weight
6H	No	1,215"	SL426130	1,166
6H	Yes	1,215"	SLP426130	1,381
7H	No	1,418"	SL427130	1,306
7H	Yes	1,418"	SLP427130	1,521

#### 7 Unit System

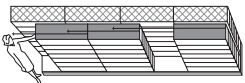

Features 4 stationary back units and 3 sliding front units

#### 36" Shelving / 148" Wide

HT	Shelf	LFI	Stock No.	Weight
6H	No	1,449"	SL366148	1,417
6H	Yes	1,449"	SLP366148	1,730
7H	No	1,740"	SL367148	1,592
7H	Yes	1,740"	SLP367148	1,2038

#### 42" Shelving / 172" Wide

HT	Shelf	LFI	Stock No.	Weight
6H	No	1,701"	SL426172	1,628
6H	Yes	1,701"	SLP426172	1,929
7H	No	1,985"	SL427172	1,824
7H	Yes	1,985"	SLP427172	2,125

# Index

<b>A</b>		Pressboard	19	<b>P</b>	
Adhesive Dividers	34	Tyvek Expansion	13-14, 18-19	Pediatric Growth Charts	85
Adhesive Fasteners	23	Tyvek Laminated	20	PMA Compatible Labels	36, 55
Adhesive Pockets	25	File Name Labels	60	PMA Compatible Year Labels	55
Aging Labels	55-57	File Outguides	24	Pocket Folders	10-12, 14
Allergy Labels	64-66	File Pockets	15-16	Pockets Factory Applied	25
Alphabetic Labels	36-48	<b>FILE POCKETS</b>		Pockets File	10-12, 15-16
Ames Compatible Labels	37, 49, 55, 57	Adhesive Paper	25	Pockets See Through	26
Appointment Cards	90-93	Adhesive SeeThrough	26	P.O.S. Compatible Labels	44, 53, 55
<b>B</b>		EndTab	15-16	Pressure Sensitive Fasteners	23
Barkley Compatible Labels	38, 49, 55, 56	Mini	16	Pressure Sensitive Pockets	26
Bibbero Compatible Labels	39	TopTab	16	Progress Notes	31-33, 86, 88
Bonded Fasteners	2	File Shelving	96-99	<b>R</b>	
<b>C</b>		Fileback Dividers	28-29, 34	Recall Cards	90-93
Cabinets Open Shelf	96-97	Foamclip Fasteners	23	Reinforcing Strips	23, 61
Carts File	94-95	<b>FORMS</b>		Reynolds + Reynolds Comp. Labels	45, 53, 55
Centerpoint Filing	21-22	Clinical	84-86	<b>S</b>	
ChargeOut Slips	24	Dental	88-89	Safeguard Compatible Labels	47, 53, 55
Chart Divider Tabs	32-33	Insurance (HCFA)	87	SelfAdhesive Dividers	34
Chart Dividers	28-33	Medical	84-87	Shelving	96-99
Chart Fasteners	2, 23	Patient SignIn	87	Slash Pockets	15
Chart Labels	64-82	<b>G</b>		Smead Compatible Labels	46, 53-54, 55
Classification Folders	13-14	GBS/VRE Compatible Labels	41, 50, 55	Solid Color Labels	58-59, 83
Clinical Forms	84-89	Growth Charts	85	Spanish Labels	71
Code-A-Print Labeling Software	63	<b>H</b>		Stackable Shelving	96, 98
Collection Labels	71, 74-81	HCFA Claim Forms	87	StakNLoK Shelving	98-99
ColorCoded Labels	36-60	HIPAA Labels	67	Strip Labels	2, 63
Colored Folders	3, 9-10, 13, 15-18, 20	<b>I</b>		Sycom Compatible Labels	38, 49
Colored Pockets	15-16	Index Tabs	28-33	<b>T</b>	
COL'R TAB Compatible Label	39, 50, 55	Index Dividers-Stock	31	TAB Compatible Labels	48, 54, 55, 57
Colwell Jewel Tone Compatible Labels	40, 50, 55	Index Sets-Stock	30	Track Systems	97-99
Communication Labels	64-82	InHealth (PFSI) Compatible Labels	45	Traco Compatible Labels	47, 55
Confidential SignIn System	87	<b>J</b>		Transcription Labels	62
Controlled Alpha Placement System	37	Jeter Compatible Labels	42-43, 51-52, 55-57, 59	Twin Prong Fasteners	23
ControlOfax Compatible Labels	40, 50, 55	<b>K</b>		<b>UV</b>	
Conversion Tabs & Flaps	23-24	Kraft Pockets	16, 25	UClip Fasteners	23
Custom Chart Dividers	28-29	<b>L</b>		UFilE M Strips	11, 12, 23
Custom Folders	2, 19	<b>LABELS</b>		Vinyl Outguides	24
Custom Installed Fasteners	2-3	Aging	55-57	Vinyl Pockets	26
<b>D</b>		Allergy	64-66	<b>XYZ</b>	
Datafile Compatible Labels	41, 50	Alphabetic	36-48	Year Labels	55, 57
Dental Charting System	88-89	Billing	71-80	Ziplock Pockets	26
Divider Sheets/Tabs	32-33	Blank	60, 62-63, 83		
Dividers Custom	28-29	Chart	64-82		
Dividers Fileback	28-29, 34	Collection	71, 74-81		
Dividers SelfAdhesive	28-29, 34	ColorCoded	36-60		
DocuClip Fastener	23	Communication	64-82		
<b>E</b>		Designator	58-59		
Earflap	23	HIPAA	67		
EndTab Folders	3-15, 17-22	Insurance	73-75, 81-82		
Envelopes File	16	Laser	60, 62, 83		
Envelopes HCFA	87	MAP Comparable	55		
Expanding Fileback	34	Month	56-57		
<b>F</b>		Name	60		
Fasteners Custom Installed	2-3	Numeric	49-54		
Fasteners Standard	2-3, 23	Protectors	61		
Fastfix™	61	Signature	87		
File Cabinets	94-99	Software	63		
File Carts	94-95	Solid Color	58-59, 83		
File Doctor Compatible Labels	41	Spanish	71		
File Envelopes	16	Transcription	62		
File Fasteners	2, 23	Year	55, 57		
File Folders	1-22	Label Protectors	61		
<b>FILE FOLDERS</b>		Laptop Storage	95		
Classification	13-14	Laser Appointment Cards	90-93		
Colored	3, 9-10, 13, 15-18, 20	LockIt Pockets	26		
Custom	2, 19	<b>M</b>			
Cutless™	6	Medical Alert Labels	68, 70		
EndTab	3-15, 17-22	Medical Charting System	84		
Expansion	5, 13-14, 18-19	Month Labels	56-57		
Hanging	21-22	Mylar Protectors	61		
Kardex Compatible	17-18	<b>N</b>			
Mylar Reinforced	5, 7, 14	Name Label Protectors	61		
Pocket	10-12, 15-16	Name Labels	60		
Printed	2	Numeric Labels	49-54		
Watershed™	6	<b>O</b>			
W-Fold	5	On-Demand Labels	63		
w/Dividers	13-14	Open Shelf Folders	3-15, 17-20		
w/Fasteners	3-13, 17-18	Outguides	24		
w/Pockets	10-12, 14				

We have made every attempt to correctly acknowledge Trademarks which appear in this catalog to clarify brand names of materials used in the manufacture of particular items; products supplied to us for resale; or products manufactured for us to be compatible with other manufacturer's lines.

AMES® TAB Products Company LLC; BARKLEY® Division of International Filing Company; BIBBERO® Bibbero Systems, Inc.; COL'R TAB® Xertrex International, Inc.; CONTROL-O-FAX® Expressbill/Web/MD-Healthcon; Cutless®, International Paper Company; Datafile®, TAB Products, Company LLC DOCUCLIP® Avery Dennison, Inc.; File Doctor® File Doctor, Inc.; FOAMCLIP® Permclip Products Corp.; GBS® (VRE) GBS Filing Systems; IN-HEALTH® Professional Filing Systems Inc.; JETER® TAB Products Company LLC.; Medical Arts Press®, Staples, Inc.; PERMCLIP® Permclip Products Corp.; PMA® Integrated Filing Solutions; POS® Professional Office Systems, Inc.; Reynolds & Reynolds® Reynolds & Reynolds Co.; SAFEGUARD® Safeguard Business Systems, Inc.; SMEAD® Smead Manufacturing Company; SYCOM® New England Business Systems, Inc.; TAB® TAB Products Company LLC; TABBIES® Xertrex International Corp.; TYVEK® E.I. DuPont Corporation; UAL/VERIAD®, Moore Business Systems; Watershed®, International Paper Company

**SIMPLE SOLUTIONS  
TO IMPROVE RECORDS  
MANAGEMENT**

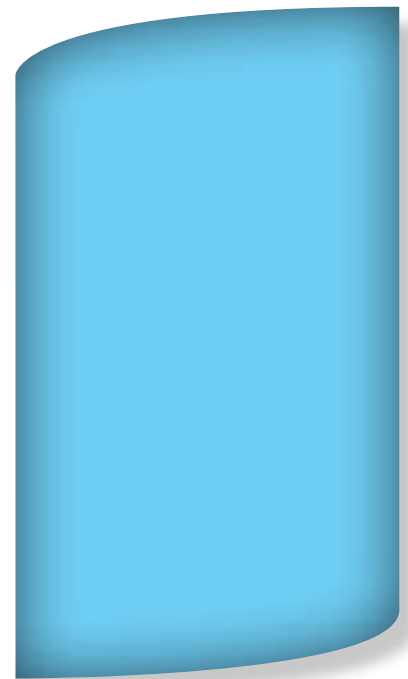
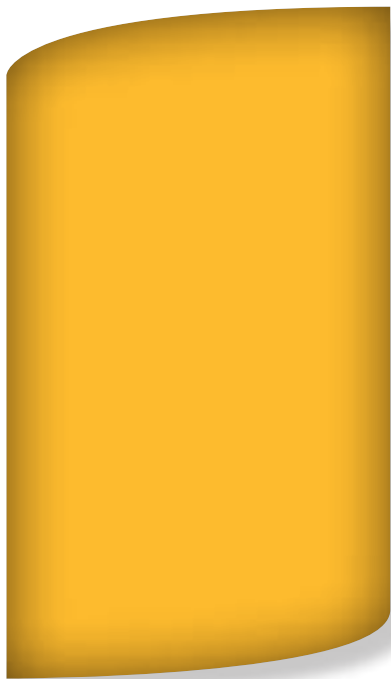

Folders | Indexes | Chart Dividers | Fasteners | Pockets | Labels | Forms  
Appointment Products | Storage | Misc Filing Products